

SG 8960

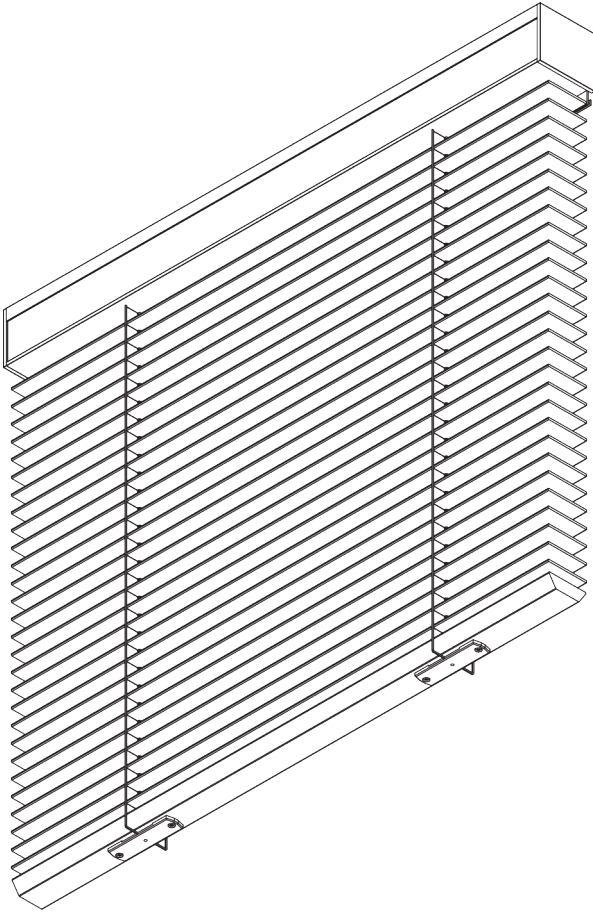
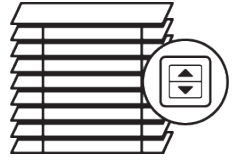

PRODUCT INFORMATION

- **Operation:** motorised
- **Range:** L
- **Fitting:** ceiling, wall
- **Colours:** refer to Silent Gliss slat collection

Features:

- Optimised light control
- Various control options
- Wood, aluminium and leather slats
- Slat width: 50 mm
- Headrail slat cover
- Choice of ladder cord or decorative slat tape

SYSTEM SPECIFICATIONS

A. SYSTEM DIMENSIONS



Wood / Leather: 2.4 m
Aluminium: 3.6 m

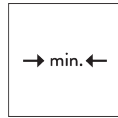

65 cm



Wood / Leather: 2.75 m
Aluminium: 3.6 m



Wood / Leather: 4.6 m²
Aluminium: 10 m²

Slat stack heights

Note: stack size will be larger when tapes are used

Wooden

	50 mm	X								
			60	90	120	150	180	210	240	275
			12	15	17	20	22	25	27	30

(cm)

Leather

	50 mm	X								
			60	90	120	150	180	210	240	275
			16	18	20	22	24	26	28	30

(cm)

Aluminium

	50 mm	X				
			100	200	300	360
			10	13	17	20

(cm)

B. PROFILE

Profile information

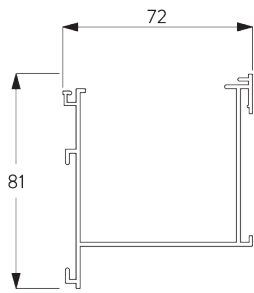

SG 8935
Profile

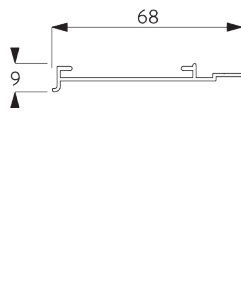

SG 8936
Profile

C. HOW TO MEASURE

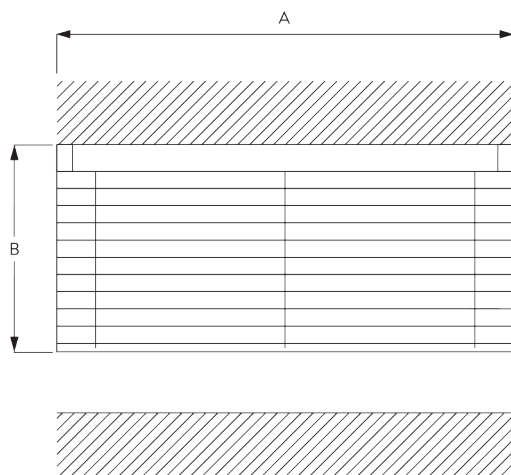

A: System width
B: System height

D. SPECIFICATION TEXT

EN

Silent Gliss SG 8960 Electrically Operated Venetian Blind. Supplied made to measure and complete comprising aluminium headrail SG 8935 and cover SG 8936 incorporating matching colour slat. System fixed with clamps SG 3033 to ceiling or wall at 450 mm intervals plus one at 100 mm from each end. Supplied with motor SG 11095 with which permits raising, lowering and tilting of the slats / operation by third party control system subject to suitable interface by others. Optional motor SG 11096 with integrated receiver for use with radio control system SG 9940 (hand, wall mounted transmitters and SG Move app). All wireless controls at extra cost. Slat colours to be chosen from Silent Gliss 50 mm aluminium / wood / leather range.

SV

Silent Gliss SG 8960 Persiennsystem med motor. Lameller 50 mm. Levereras i kundens mått komplett med aluminiumkassett SG 8935 och täcklock SG 8936 med färgmatchande lameller. Montering med SG 3033 mot vägg eller mot tak, 100 mm från varje ände på kassett samt med c/c 450 mm. Levereras med motor SG 11095 eller SG 11096 med radiomottagare. Motorn sköter steglös upp- och nerrullning samt vinkling av lamellerna. Kan styras via väggkontakt/ via fjärrkontroll system SG 9940 (handhållen, väggmonterad eller via app Move. Även via externt styrsystem. Radiokomponenter mot tillägg. Färg lameller väljs från Silent Gliss kollektion med 50 mm lameller i alu, trä eller läder.

NO

Silent Gliss SG 8910 Persiennesystem med motor. Lameller med 50 mm dybde. Leveres på mål. Komplet med aluminiumkassett. SG8935 og deksel SG8936, som matcher med lamellene. Montering med SG 3033 mot vegg eller tak. 100 mm fra hver ende på kassetten samt med c/c 450 mm. Levers med motor SG11095 eller SG 11096 med radiomottaker. Motoren gir en jevn/ trinnløs vinkling og opp/ned kjøring av lamellene. Kan styres med veggbryter, fjernkontroll SG 9940 (håndholdt / veggmontert eller via app Move). Kan også betjenes med eksternt system. Radiokomponenter kommer i tillegg. Farge på lamellene velges fra Silent Gliss kolleksjon med 50mm lameller i alu, tre eller skinn.

DA

Silent Gliss SG 8960 elektrisk persienne. Leveres i ønsket længde og komplet, bestående af aluminiumkassette SG 8935 og afdækning SG 8936 med matchende farvet lamel. Systemet fastgøres med klemmer SG 3033 til loft eller væg med afstande på 450 mm plus en på 100 mm fra hver ende. Leveres med motor SG 11095, der gør det muligt at løfte, sænke og hælde lamellerne / styring med styresystemer fra tredjeparter, forudsat at der er en egnet grænseflade fra andre. Valgfri motor SG 11096 med integreret modtager til brug med radiostyresystem SG 9940 (manuel, vægmonterede transmittere og SG Move-app). Al trådløs styring mod ekstra betaling. Lamellernes farve vælges blandt Silent Gliss 50 mm aluminium / træ / læder program.

FITTING

A. FITTING INFORMATION

For detailed fitting information, visit the Silent Gliss website.

Fixing points

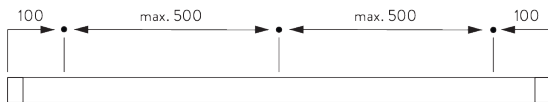

B. CEILING FITTING

Clamp SG 3003

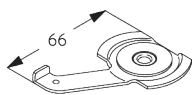
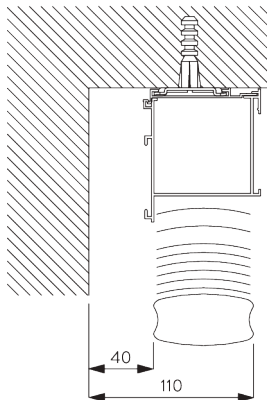

SG 3003
Clamp

C. WALL FITTING

Clamp SG 3003

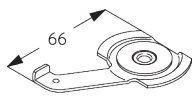
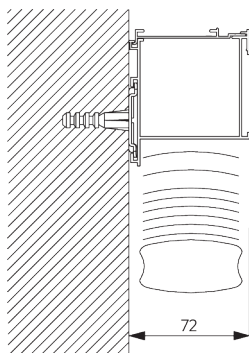

SG 3003
Clamp

D. FITTING WITH SIDE GUIDE OPTION

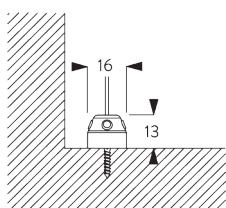

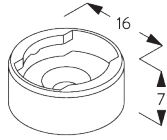

SG 8235
Side guide wire base short

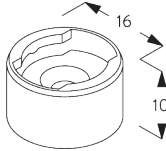

SG 8236
Side guide wire base long

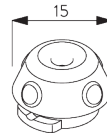

SG 8237
Side guide wire holder

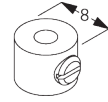

SG 8249
Side guide device

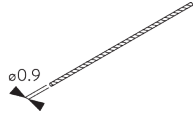

SG 10120
Side guide wire \varnothing 0.9 mm

SYSTEM OPTIONS

A. HEADRAIL SLAT COVER

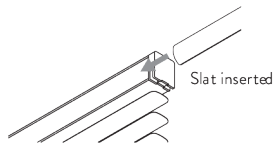

- A slat is inserted into the headrail for perfect matching of colours and materials to avoid the need to fit a cumbersome valance.
- For leather slat blinds there is the option of a leather covered headrail at an additional cost.
- Leather covered slats cannot be specified with decorative (external) slat tapes. The blind hardware is supplied matching the slat colour.

B. SIDE GUIDES

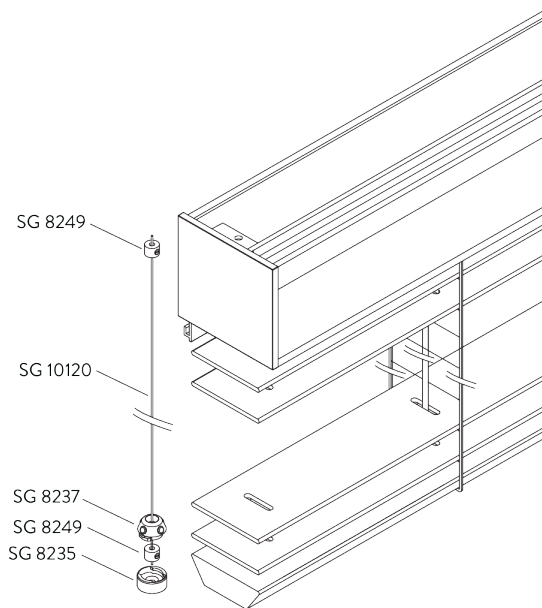

Additional parts:

- 2x SG 8235 Side guide wire base short
- 2x SG 8237 Side guide wire holder
- 4x SG 8249 Side guide device
- 2x SG 10120 Side guide wire \varnothing 0.9 mm

Note:

- Up to 15° from vertical

MOTOR & CONTROLS

A. MOTOR FEATURES

Motors	SG 11095	SG 11096
Motor Features		
Soft start / stop	●	●
Built-in receiver		●
Electronic end-stop	●	●
Electronic revolution counter (unlimited revolution)	●	●
Intermediate positions possible		●
Noiseless stop	●	●
IP class	IP 54	IP 54
Control Features		
Mains power control	●	
SG Control L (built-in receiver)		●
Suitable for most major home automation systems (with suitable interface)	●	●

B. MOTOR SPECIFICATIONS

Motors	Voltage	Current	Frequency	Speed	Frequency receiver
SG 11095	230 V AC	0.5 A	50 Hz	35 rpm	n/a
SG 11096	230 V AC	0.5 A	50 Hz	35 rpm	868 MHz

C. OPERATING METHODS

See catalogue "controls" for details.

Wall Switch



System can be operated by fixed wall switch.

SG Control L



Various radio hand-held and wall transmitters available.



Silent Gliss Move App.

D. WIRING
DIAGRAMS



Refer to Silent Gliss website.

PARTS

A. STANDARD PARTS



SG 3003

Clamp

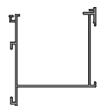

SG 8935

Profile



SG 8936

Profile

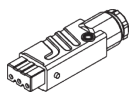

SG 9917

Hirschmann portable socket-outlet
STAK 3 N

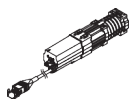

SG 11095

Motor 230V AC, JA 04/35 comfort

B. OPTIONAL PARTS



SG 8235

Side guide wire base short

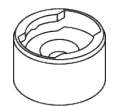

SG 8236

Side guide wire base long



SG 8237

Side guide wire holder

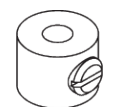

SG 8249

Side guide device

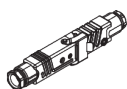

SG 9916

Hirschmann plug set



SG 10120

Side guide wire ø 0.9 mm



SG 10300

Radio hand held 1 channel



SG 10302

Radio hand held 5+1 channel

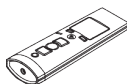

SG 10303

Radio hand held 10+2+1 channel



SG 10804

Radio hand held 15+5+1 channel

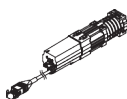

SG 11096

Motor 230V AC, JA 04/35
comfort, radio receiver



SG 11480

Radio wall transmitter 1 channel



SG 11490

Radio wall transmitter 5+1 channel