

# SG 2810

---

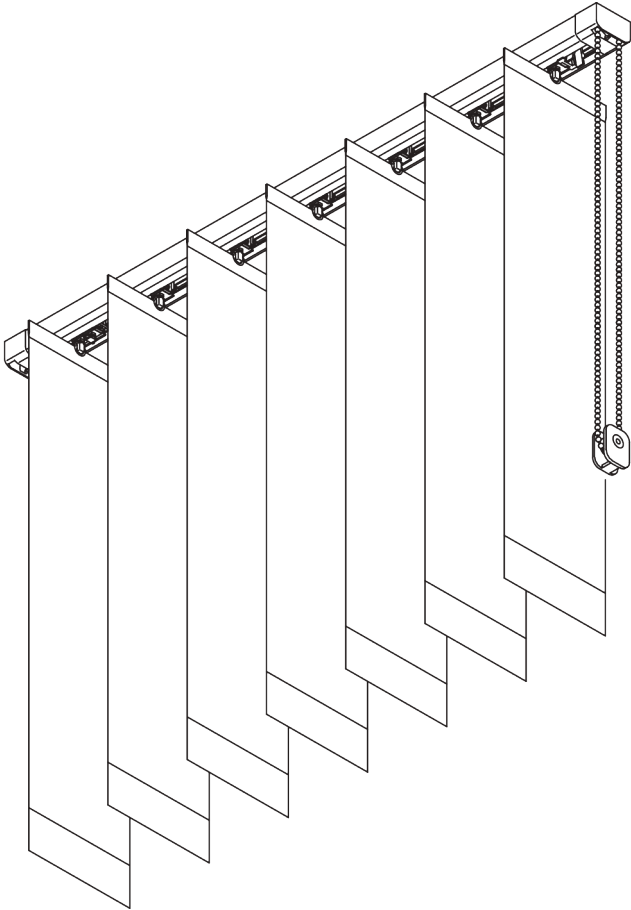
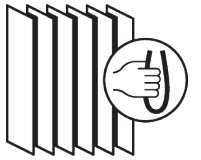

## PRODUCT INFORMATION

- **Operation:** chain
- **Range:** S - M
- **Fitting:** ceiling, wall, recess
- **Colours:** white RAL 9016 or anodised aluminum, special colours possible
- **Fabrics:** refer to Silent Gliss fabric collection

### **Features:**

- Optimised light control
  - Mono controlled
  - Pull override protection
  - Louvre width: 127 mm (standard), 89 mm
  - Vertical Waves
  - Bendable
- 08/2024/V1

# SYSTEM SPECIFICATIONS

## A. SYSTEM DIMENSIONS



127 mm louvres: 5 m  
89 mm louvres: 3.8 m



40 cm



4 m



200 g per louvre

## Max. system widths

	127 mm 89 mm	5 m 3.8 m
	127 mm 89 mm	4 m 3.1 m
	127 mm 89 mm	4 m 3.1 m

## Stack sizes

		100	150	200	250	300	350	400	450	500
127 mm		27	35	42	50	57	65	72	80	87
		21	25	28	32	36	39	43	47	50
89 mm		29	40	50	60	69	80			
		20	25	30	35	39	45			

(cm)

## B. PROFILE

### Profile and bending information

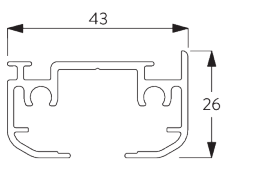

**SG 2601**

Profile

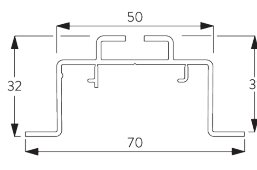

**SG 2614**

Recess profile



Radius:  
>75 cm

## C. HOW TO MEASURE

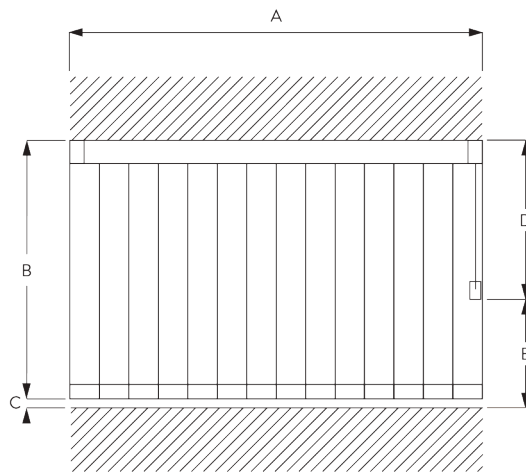

- A: System width
- B: System height
- C: Distance between floor and fabric
- D: Chain height
- E: Safety retainer SG 10731 min. 150 cm above floor

## Light gap

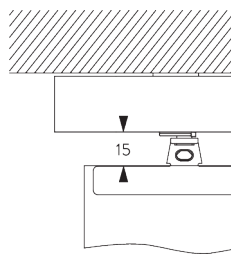

## D. SPECIFICATION TEXT

### EN

Silent Gliss SG 2810 Chain Operated Vertical Blind System. Comprises aluminium profile SG 2601 supplied made to measure powder coated white or silver anodised. Assembled complete with mono control chain SG 2872 and rotation elements to suit louvre width 127 mm SG 2623 / 89 mm SG 2625. Top fixed with clamp SG 2616 at max 300 mm centres + 1. Wall fixed with bracket SG 2616 in conjunction with SG Smart Fix Recess fixed option with recess profile SG 2614 and wedges SG 5118. Fabric supplied from Silent Gliss fabric range.

### SV

Silent Gliss SG 2810 Lamellsystem med kedja. Innefattar aluminium profil SG 2601 i kundmått, pulverlackerad i vitt eller i alu finish. Monterad komplett med mono kontroll kedja SG 2872 och pivåer för lamellbredd 127 mm SG 2623 / 89 mm SG 2625. Takmontering med fäste SG 2616 c/c 300 mm. + 1. Vägghäring med fäste SG 2616 samt Smart Fix vinklar. Infällningsmöjlighet med profil SG 2614 och kilar SG 5118. Textil från Silent Gliss textilprogram prisgrupp 1-4.

### NO

Silent Gliss SG 8300 Lamellsystem med kjede. Leveres på ønsket mål. Består av aluminiumsprofil SG 2601, pulverlakkert i hvit eller i alu finish. Montert komplett med mono betjeningskjede SG 2872, rotasjonselement tilpasset lamellbredde 127 mm SG 2323 / 89 mm SG 2625. Takmontering med feste SG 2616 c/c 300 mm. +1. Veggmontering med feste SG 2616, samt Smart Fix vinkler. Innfellingsmulighet med profil SG 2614 og kile SG 5118. Tekstil fra Silent Gliss tekstilkolleksjon 1-4.

### DA

Silent Gliss SG 2810 lodret rullegardinsystem med kædestyring. Består af aluminiumprofil SG 2601 i ønsket længde, i hvid pulverlakering eller sølv-anodiseret. Helt samlet med styrekæde SG 2872 og rotationselementer passende til lamelbredde 127 mm SG 2623 / 89 mm SG 2625. Loftmonteres med klemme SG 2616 med højst 300mm afstand + 1. Vægmonteres med beslag SG 2616 i sammenhæng med SG Smart Fix indfældning fast tilbehør med indfældningsprofil SG 2614 og kiler SG 5118. Stoffet leveres fra Silent Gliss stofprogrammet.

# FITTING

## A. FITTING INFORMATION

For detailed fitting information, visit the Silent Gliss website.

### Fixing points

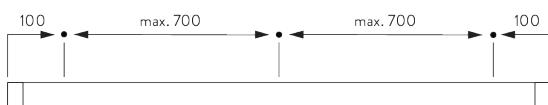

## B. CEILING FITTING

### Bracket SG 2616

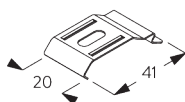
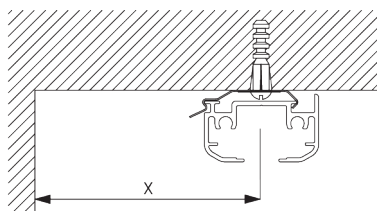

**SG 2616**

Bracket

Min. wall distance louvres	X mm
89 mm	65
127 mm	85
Vertical Waves 89 mm	115
Vertical Waves 125 mm	140

## C. RECESS FITTING

### Recess profile SG 2615

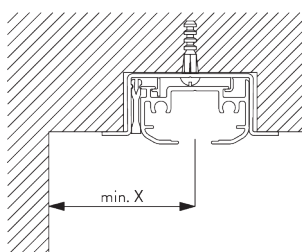

Recess profile SG 2615 can not be bent!  
One wedge SG 5118 per fixing point.  
For detailed recess fitting, visit the Silent Gliss website.

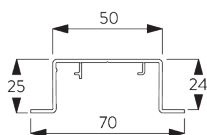

**SG 2615**

Recess profile

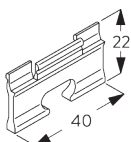

**SG 5118**

Wedge

Min. wall distance louvres	X mm
89 mm	65
127 mm	85
Vertical Waves 89 mm	115
Vertical Waves 125 mm	140

## D. WALL FITTING

### Smart Fix

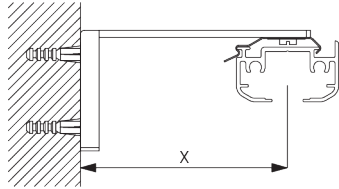

**Smart Fix SG 11201 - SG 11204 and bracket SG 2616:**  
Screw SG 10395 (M4x6) needed

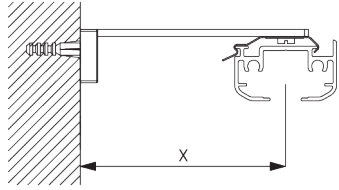

**Square Smart Fix SG 11211 - SG 11214 and bracket SG 2616:**  
Screw SG 10395 (M4x6) needed

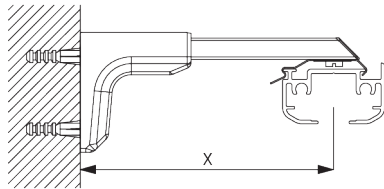

**Universal Smart Fix SG 11154 - SG 11156 and bracket SG 2616:**  
Screw SG 10492 (M4x8) needed

Smart Fix	X mm
SG 11201 / SG 11211	72
SG 11202 / SG 11212	92
SG 11203 / SG 11213	112
SG 11204 / SG 11214	142
SG 11154	102-130
SG 11155	132-160
SG 11156	182-210
Min. wall distance louvres	
89 mm	65
127 mm	85
Vertical Waves 89 mm	115
Vertical Waves 125 mm	140

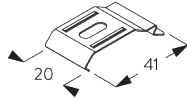

**SG 2616**  
Bracket



**SG 10395**  
Pan head screw M4x6



**SG 10492**  
Pan head screw M4x8

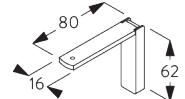

**SG 11201**  
Smart Fix 80 mm

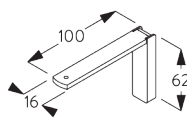

**SG 11202**  
Smart Fix 100 mm

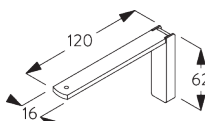

**SG 11203**  
Smart Fix 120 mm

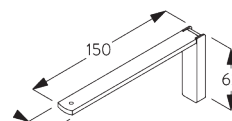

**SG 11204**  
Smart Fix 150 mm

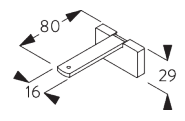

**SG 11211**  
Square Smart Fix 80 mm

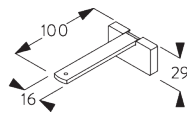

**SG 11212**  
Square Smart Fix 100 mm

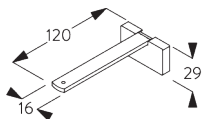

**SG 11213**  
Square Smart Fix 120 mm

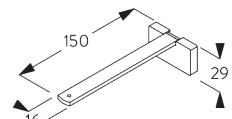

**SG 11214**  
Square Smart Fix 150 mm

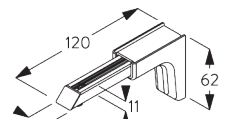

**SG 11154**  
Universal Smart Fix 120 mm

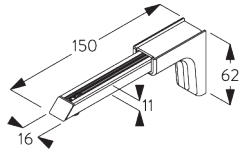

**SG 11155**  
Universal Smart Fix 150 mm

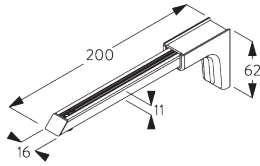

**SG 11156**  
Universal Smart Fix 200 mm

# SYSTEM OPTIONS

## A. VERTICAL WAVES

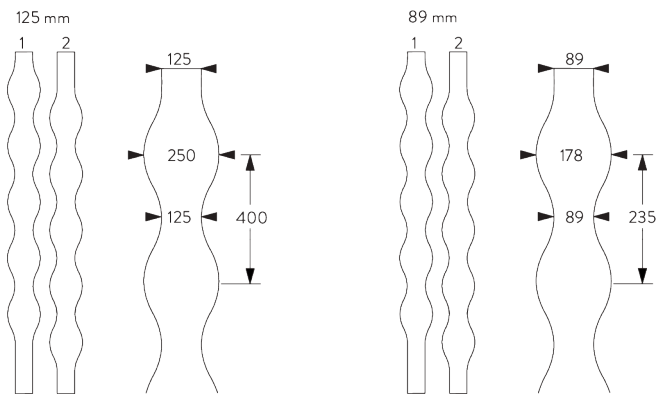
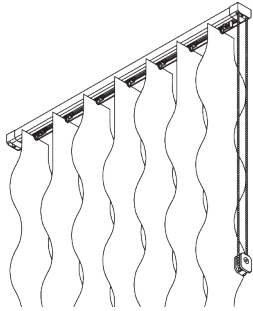

3D Vertical Waves only applicable with 125 mm louvres.

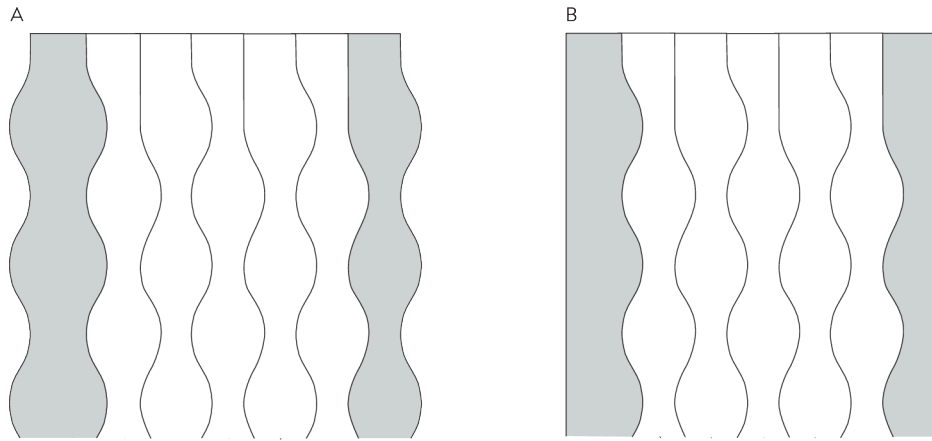

Wall ending

A: Wavy edge

B: Straight edge

**B. STACKING**  
**VARIATIONS**

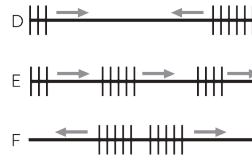
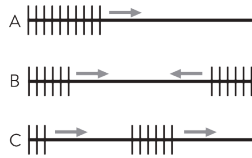

A: Single stack in one direction

B: Pair stack in two directions symmetrical

C: Pair stack in one direction asymmetrical

D: Pair stack in two directions asymmetrical

E: Multiple stacking in one direction symmetrical or asymmetrical

F: Centre stack

# PARTS

## A. STANDARD PARTS

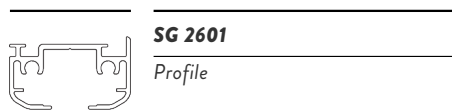

**SG 2601**

Profile

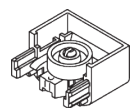

**SG 2604**

Guide

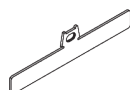

**SG 2605**

Top clip 127 mm

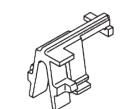

**SG 2610**

End stop

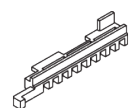

**SG 2611**

Stopper

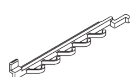

**SG 2612**

Brake

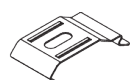

**SG 2616**

Bracket

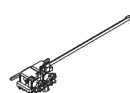

**SG 2620**

Pilot runner



**SG 2623**

Rotation element set 127 mm

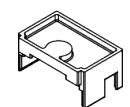

**SG 2627**

Cover



**SG 2865**

Bead chain connector  $\varnothing$  4.6 mm



**SG 2872**

Bead chain plastic  $\varnothing$  4.6 mm



**SG 2888**

Bottom link 127 mm

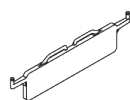

**SG 2892**

Bottom weight 127 mm / 5"

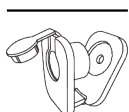

**SG 10731**

Child safety retainer set

## B. OPTIONAL PARTS

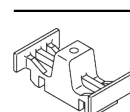

**SG 2608**

End stop

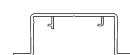

**SG 2615**

Recess profile

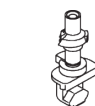

**SG 2618**

Shaft



**SG 2624**

Rotation element set 100 mm



**SG 2625**

Rotation element set 89 mm



**SG 2735**

Holder

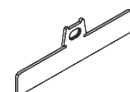

**SG 2813**

Top clip 89 mm

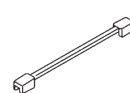

**SG 2881**

Spring

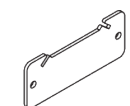

**SG 2884**

Bottom weight 89 mm



**SG 2889**

Bottom link 89 mm



**SG 2890**

Bottom weight 127 mm



**SG 3340**

Cord/chain weight

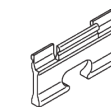

**SG 5118**

Wedge



**SG 10395**

Pan head screw M4x6



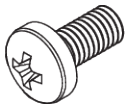

---

**SG 10492**

Pan head screw M4x8

---

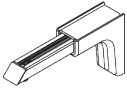

---

**SG 11154**

Universal Smart Fix 120 mm

---

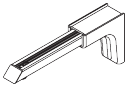

---

**SG 11155**

Universal Smart Fix 150 mm

---

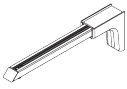

---

**SG 11156**

Universal Smart Fix 200 mm

---

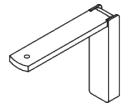

---

**SG 11201**

Smart Fix 80 mm

---

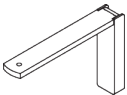

---

**SG 11202**

Smart Fix 100 mm

---

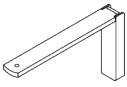

---

**SG 11203**

Smart Fix 120 mm

---

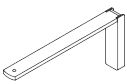

---

**SG 11204**

Smart Fix 150 mm

---

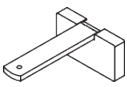

---

**SG 11211**

Square Smart Fix 80 mm

---

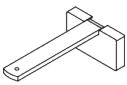

---

**SG 11212**

Square Smart Fix 100 mm

---

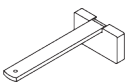

---

**SG 11213**

Square Smart Fix 120 mm

---

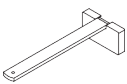

---

**SG 11214**

Square Smart Fix 150 mm

---





