

SG 2730

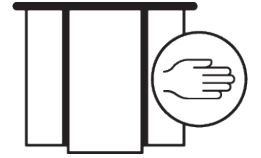

FLEX

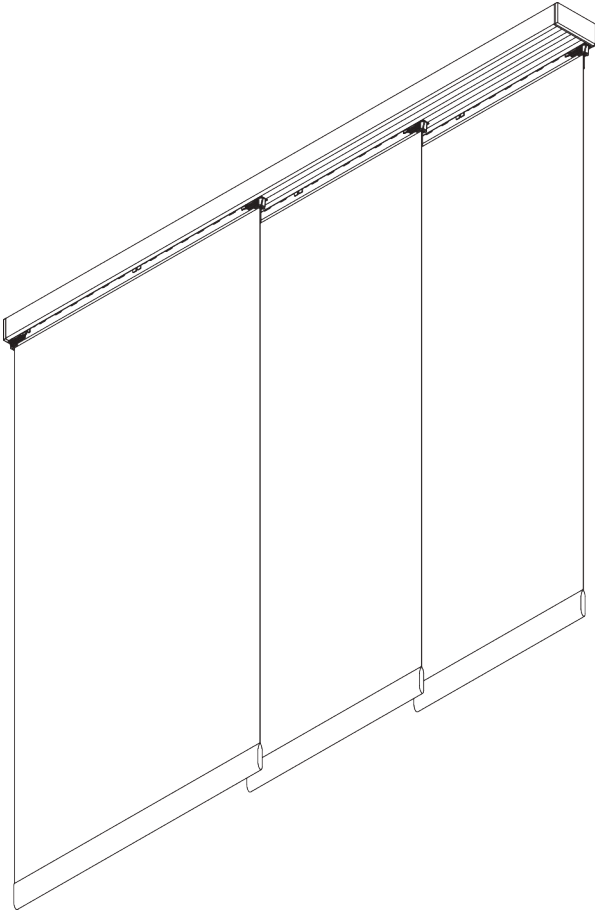

PRODUCT INFORMATION

- **Operation:** hand
- **Range:** S - L
- **Fitting:** ceiling, wall
- **Colours:** white RAL 9016, anodised aluminum
- **Fabrics:** refer to Silent Gliss fabric collection

Features:

- 2-component (2C) roller technology
- Silent and smooth running
- Free floating or connectable panels
- Bendable

SYSTEM SPECIFICATIONS

A. SYSTEM DIMENSIONS



Panels free floating:
unlimited
Panels connected: 6 m

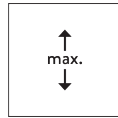

3 m



Max. 2 kg per m

B. PROFILE

Profile and bending information

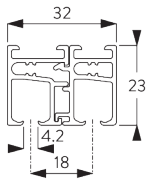

SG 10132

Profile 2-channel

Radius:
✓ 15 cm, >25 cm

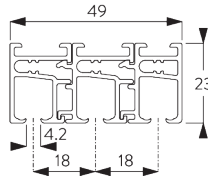

SG 10133

Profile 3-channel

Radius:
✓ 15 cm, >25 cm

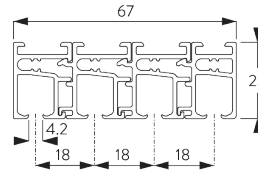

SG 10134

Profile 4-channel

Radius:
✓ 15 cm, >25 cm

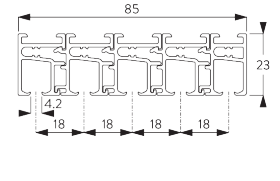

SG 10135

Profile 5-channel

Radius:
✓ 15 cm, >25 cm

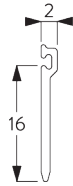

SG 10179

Profile



SG 10180

Carrier flexible

C. HOW TO MEASURE

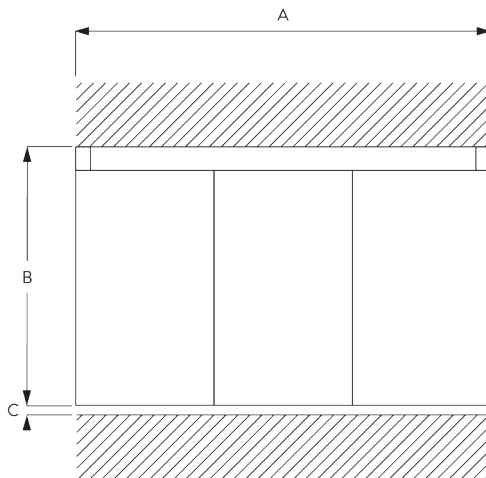

A: System width

B: System height

C: Distance between floor and fabric

Dimensions of Panels

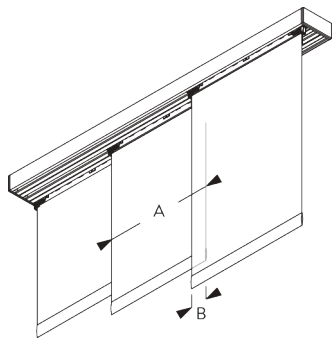

Free floating:

A: Recommended panel width: 500 - 1200

Connected:

A: Recommended panel width: 500 - 1200

B: Overlap: min. 120

D. SPECIFICATION

TEXT

EN

Silent Gliss SG 2730 Flex System. Curved panel glide system supplied made to measure and complete comprising profiles SG 10132 / SG 10133 / SG 10134 / SG 10135 as necessary with carrier SG 10180 with associated components and flexible lead bottom weight SG 10233. Fabric panels stack right hand single / left hand single / pair / centre. Hand operated with panels unconnected / connected using draw rod of suitable height. Ceiling fix direct with suitable screw. Wall fix with SG Smart Fix brackets. Max. distance 800 mm between fixing points. Fabric to be chosen from Silent Gliss fabric collection, Price Group 1 / 2 / 3.

SV

Silent Gliss SG 2730 Flex böjbart skärmgardinsystem. Levereras komplett i specificerat mått innefattande profil 10132 / SG 10133 / SG 10134 / SG 10135 med vagnar SG 10180 med tillhörande komponenter samt tyngdprofil SG 10233. Textilpaneler med sidöppning höger / vänster / mittöppning / centrerad. Manövreras för hand med individuellt flyttbara textiler/kopplade med dragstav anpassad till lämplig höjd. Takmontering med skruv direkt i tak anpassad efter fästmaterial. Vägghmontering med SG Smart Fix. Max. c/c 800 mellan fästpunkter. Textil från Silent Gliss textilprogram i prisgrupp 1-4.

NO

Silent Gliss SG2700 Flex bøypart panelsystem. Leveres komplett måltilpasset. Består av profil 10132/SG10133/SG10134/SG10135 med vogner SG10180 inkl. tilhørende komponenter samt tyngdeprofil SG10233. Tekstilpaneler med sideåpning høyre/venstre / midtåpning / sentrert. Betjenes for hånd med individuelt bevegelige tekstiler/koblet med betjeningsstav, tilpasset egnet høyde. Takmontering med skruv direkte i tak, tilpasset monteringsmaterial. Veggmontering med SG Smart Fix vinkler. Max c/c 800 mm mellom festepunkt. Tekstil fra Silent Gliss tekstilkolleksjon i prisgruppe 1-4.

DA

Silent Gliss SG 2730 Flex System. Bøjeligt panelsystem, der leveres i ønsket længde og komplet, bestående af profilerne SG 10132 / SG 10133 / SG 10134 / SG 10135 efter behov med vogn SG 10180 med tilhørende komponenter og fleksibel tyngdeprofil SG 10233. Tekstilpaneler med sideåbning højre side enkelt / venstre side enkelt / par / centreret. Betjenes manuelt hvis panelerne ikke er tilsluttede / tilsluttede med en trækstang af passende højde. Fastgøres direkte i loftet med passende skruer. Vægmonteres med SG Smart Fix. Afstand mellem fastgøringspunkter højst 800 mm. Stoffet vælges fra Silent Gliss stofprogrammet, prisgruppe 1 / 2 / 3.

FITTING

A. FITTING INFORMATION

Fixing points

For detailed fitting information, visit the Silent Gliss website.

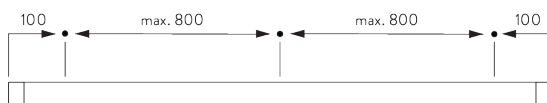

B. CEILING FITTING

Direct fitting

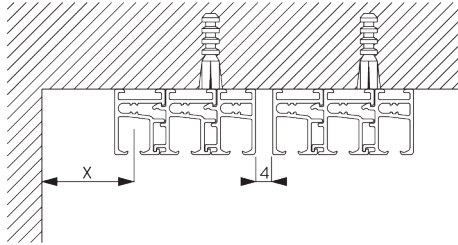

X = depending on room conditions

C. WALL FITTING

Smart Fix

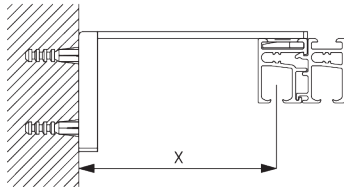

Smart Fix with slot SG 11206 - SG 11208:

Screw SG 10395 (M4x6) needed.

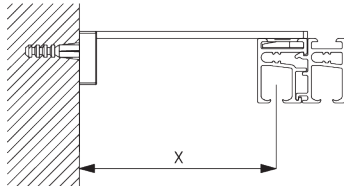

Square Smart Fix with slot SG 11216 - SG 11218:

Screw SG 10395 (M4x6) needed.

Smart Fix	X mm (SG 10132)	X mm (SG 10133)	X mm (SG 10134)	X mm (SG 10135)
SG 11206 / SG 11216	50	32	-	-
SG 11207 / SG 11217	70	52	34	-
SG 11208 / SG 11218	90	72	44	on request

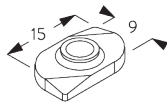

SG 10160

Slot nut



SG 10395

Pan head screw M4x6

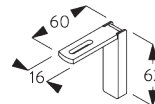

SG 11206

Smart Fix with slot 60 mm

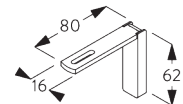

SG 11207

Smart Fix with slot 80 mm

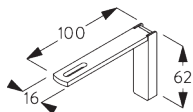

SG 11208

Smart Fix with slot 100 mm

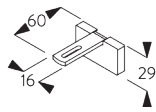

SG 11216

Square Smart Fix with slot 60 mm

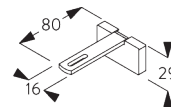

SG 11217

Square Smart Fix with slot 80 mm

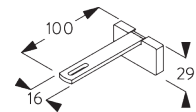

SG 11218

Square Smart Fix with slot 100 mm

SYSTEM OPTIONS

A. OPERATION

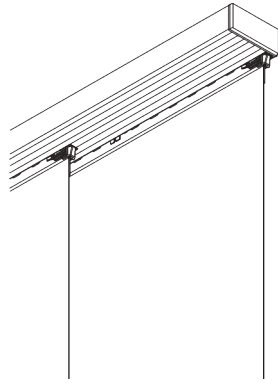

Free floating (unconnected panels)

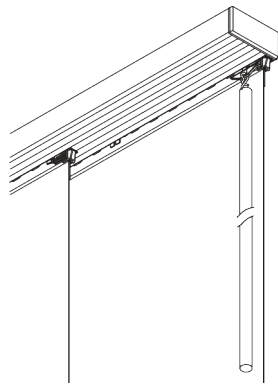

Connected panels (draw rod optional)

B. PANEL STACKING (CONNECTED)



Single stack

Note: dot = fixed panel



Pair stack

Note: dot = fixed panel

Other variations are possible. Same splitting for curved profiles.

PARTS

A. STANDARD PARTS

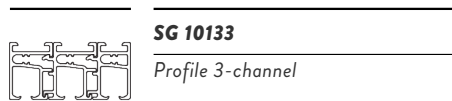

SG 10133
Profile 3-channel



SG 10159
Countersunk head screw 3.5x13



SG 10163
End cover

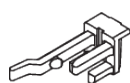

SG 10167
Clip left

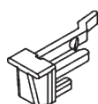

SG 10168
Clip right



SG 10179
Profile



SG 10180
Carrier flexible

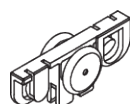

SG 10200
2C roller

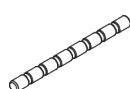

SG 10233
Lead weight 100 gr/m



SG 10234
Fabric weight glass

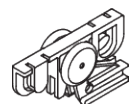

SG 10237
Clip holder



SG 10248
Screw Pozi 4.5x70 mm SPAX

B. OPTIONAL PARTS

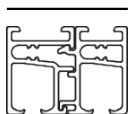

SG 10132
Profile 2-channel



SG 10134
Profile 4-channel



SG 10135
Profile 5-channel



SG 10156
End stop



SG 10160
Slot nut



SG 10162
End cover



SG 10164
End cover



SG 10165
End cover

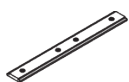

SG 10177
Connection bridge

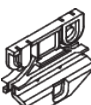

SG 10196
Eyelet for draw rod



SG 10235
Sticker for screw head

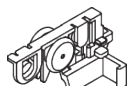

SG 10239
Angle left



SG 10241
Angle right

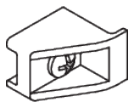

SG 10243
Angle



SG 10244
Slider



SG 10247
Screw Pozi 4.5x50 mm SPAX



SG 10395
Pan head screw M4x6



SG 10430
Draw rod 50 cm



SG 10431
Draw rod 75 cm



SG 10432
Draw rod 100 cm



SG 10433
Draw rod 125 cm



SG 10434
Draw rod 150 cm

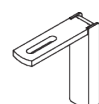

SG 11206
Smart Fix with slot 60 mm

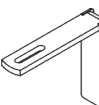

SG 11207
Smart Fix with slot 80 mm

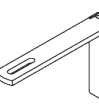

SG 11208
Smart Fix with slot 100 mm



SG 11216
Square Smart Fix with slot 60 mm



SG 11217
Square Smart Fix with slot 80 mm

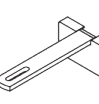

SG 11218
Square Smart Fix with slot 100 mm

