

SG 2700

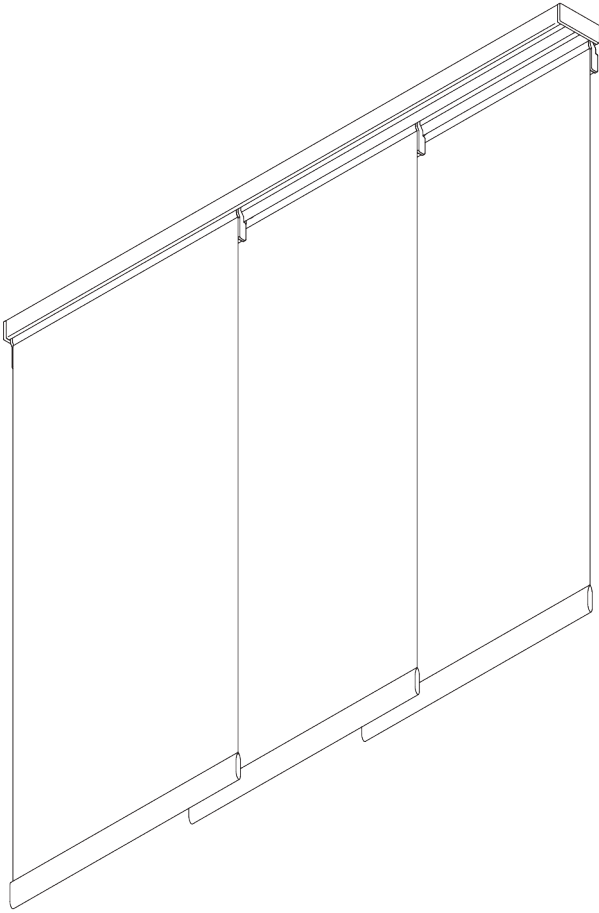
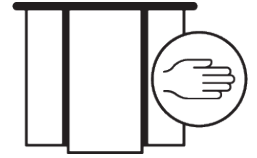

PRODUCT INFORMATION

- **Operation:** hand
- **Range:** S - L
- **Fitting:** ceiling, wall, recess
- **Colours:** white RAL 9016 or anodised aluminum, special colours possible
- **Fabrics:** refer to Silent Gliss fabric collection

Features:

- 2-component (2C) roller technology
- Silent and smooth running
- Aluminium carriers
- Free floating or connectable panels

SYSTEM SPECIFICATIONS

A. SYSTEM DIMENSIONS



Panels free floating:
unlimited
Panels connected: 6 m

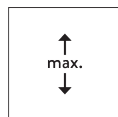

4 m



Max. 2 kg per m

B. PROFILE

Profile information

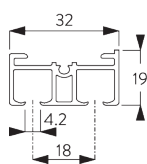

SG 10122

Profile 2-channel

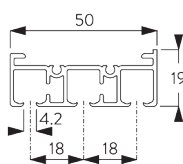

SG 10123

Profile 3-channel

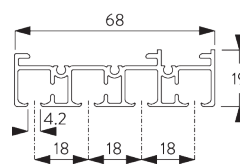

SG 10124

Profile 4-channel

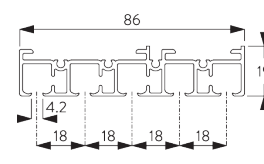

SG 10125

Profile 5-channel

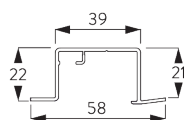

SG 10172

Recess profile 2-channel

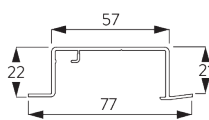

SG 10173

Recess profile 3-channel

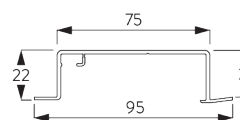

SG 10174

Recess profile 4-channel

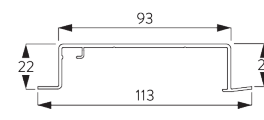

SG 10175

Recess profile 5-channel

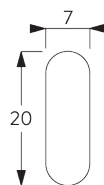

SG 2004

Bottom bar 20x7 mm

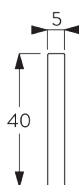

SG 2005

Bottom bar 40x5 mm

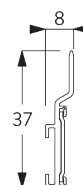

SG 10230

Carrier alu

**C. HOW TO
MEASURE**

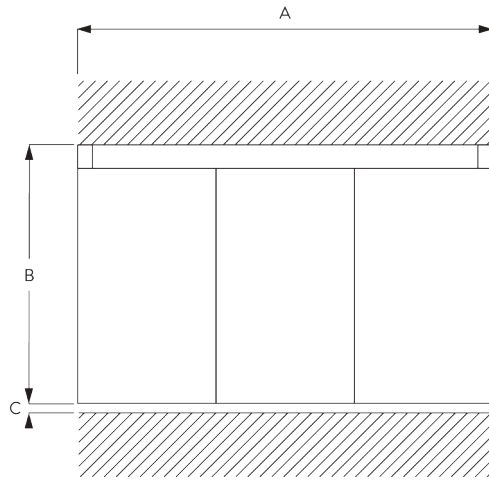

A: System width
B: System height
C: Distance between floor and fabric

Dimensions of Panels

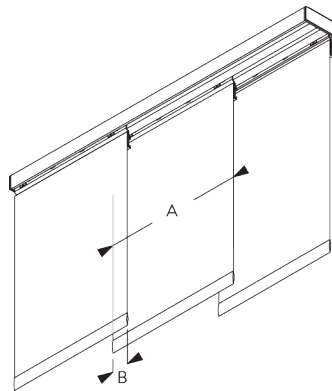

Free floating:

A: Recommended panel width: 500 - 1200

Connected:

A: Recommended panel width: 500 - 1200

B: Overlap: min. 50

D. SPECIFICATION

TEXT

EN

Silent Gliss SG 2700 Panel Glide System. Supplied made to measure and complete comprising profiles SG 10122 / SG 10123 / SG 10124 / SG 10125 as necessary with carriers SG 10230 with associated components and bottom weight SG 2004. Fabric panels stack right hand single / left hand single / pair / centre. Operated cord / hand / electrically (incorporating electric curtain track system SG 5600). Ceiling fixed using clamps SG 3003 / SG 3004 or brackets SG 10136 / SG 10137. Wall fix with SG Smart Fix brackets. Max. 800 mm centres. Compliant to Child Safety legislation EN 13120 when used in conjunction with Cord Retainer 10400. Fabric to be chosen from Silent Gliss fabric collection, Price Group 1 / 2 / 3 / 4.

SV

Silent Gliss SG 2700 skärmgardinsystem. Levereras komplett i specificerat mått innefattande profil 10122 / SG 10123 / SG 10124 / SG 10125 med vagnar SG 10230 med tillhörande komponenter samt tyngdprofil SG 2004. Textilpaneler med sidöppning höger / vänster / mittöppning / centrerad. Manövreras för hand / med lina eller med motor/ (innefattar motordrift med system SG 5600). Takmontering med beslag SG 3003 / SG 3004 eller konsoler SG 10136 / SG 10137 Vägmontering med SG Smart Fix vinklar. Max.800 mm. Uppfyller barnsäkerhetsnorm EN 13120 vid användning av lindrag linhållare SG10400. Textil från Silent Gliss textilprogram i prisgrupp 1-4.

NO

Silent Gliss SG2700 Panelsystem. Leveres komplett måltilpasset. Består av profil SG 10122 / SG 10123 / SG 10124 / SG 10125 med vogner SG 10230 inkl. tilhørende komponenter samt tyngdeprofil SG2004. Tekstilpaneler med sideåpning høyre/venstre/ midtåpning/sentrert. Betjenes med snor, manuelt eller med motor (består av motordrift med SG5600). Takmontering med beslag SG3003/SG3004 eller konsoller SG 10136 / SG 10137. Veggmontering med SG Smart Fix vinkler. Max 800 mm. Oppfyller krave til barnesikkerhetsnormen EN 13120, ved betjening med snor/snorfeste SG 10400. Tekstil fra Silent Gliss tekstilkolleksjon i prisgruppe 1-4.

DA

Silent Gliss SG 2700 panelsystem. Leveres i ønsket længde og komplet, bestående af profilerne SG 10122 / SG 10123 / SG 10124 / SG 10125 efter behov med vogne SG 10230 med tilhørende komponenter og tyngdeprofil SG 2004. Tekstilpaneler med sideåbning højre side enkelt / venstre side enkelt / par / centreret. Styres med snor / hånd / elektrisk (omfatter elektrisk drift med skinnesystemet SG 5600). Fastgøres i loftet med klemmerne SG 3003 / SG 3004 eller beslagene SG 10136 / SG 10137. Vægmonteres med SG Smart Fix beslag med en afstand på 800 mm. Overholder lovgivning om børnesikkerhed efter EN 13120., når det bruges i sammenhæng med snorholder 10400. Stoffet vælges fra Silent Gliss stofprogrammet, prisgruppe 1 / 2 / 3 / 4.

FITTING

A. FITTING INFORMATION

Fixing points

For detailed fitting information, visit the Silent Gliss website.

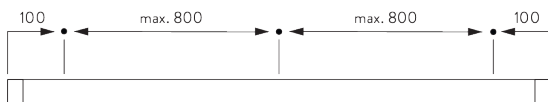

B. CEILING FITTING

Clamp SG 3003 / SG 3004

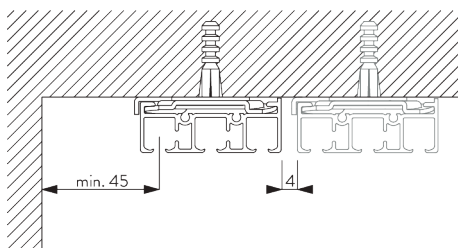

Clamp	SG 10122	SG 10123	SG 10124	SG 10125
SG 3004	X			
SG 3003		X	X	X

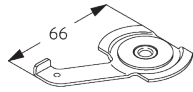

SG 3003
Clamp

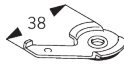

SG 3004
Clamp

Bracket SG 10136 / SG 10137

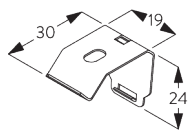
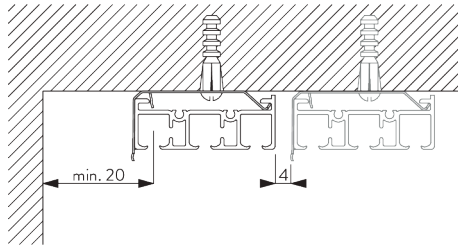

SG 10136
Bracket

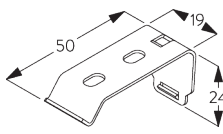

SG 10137
Bracket

Bracket	SG 10122	SG 10123	SG 10124
SG 10136	X		
SG 10137		X	X

C. WALL FITTING

Smart Fix

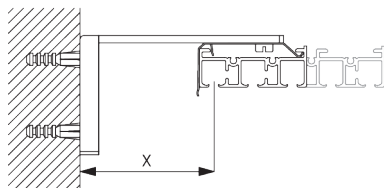

Smart Fix SG 11200 - SG 11204:
Bracket SG 10136 for 2 channel profile.
Bracket SG 10137 for more than 2 channel profiles.
Screw SG 10395 (M4x6) needed.

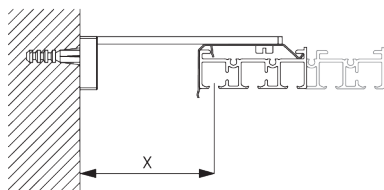

Square Smart Fix SG 11210 - SG 11214:
Bracket SG 10136 for 2 channel profile.
Bracket SG 10137 for more than 2 channel profiles.
Screw SG 10395 (M4x6) needed.

Smart Fix	X mm (SG 10122)	X mm (SG 10123)	X mm (SG 10124)	X mm (SG 10125)
SG 11200 / SG 11210	43	24	24	24
SG 11201 / SG 11211	63	44	44	44
SG 11202 / SG 11212	83	64	64	64
SG 11203 / SG 11213	103	84	84	84
SG 11204 / SG 11214	133	114	114	114
SG 11154	93-121	74-102	74-102	74-102
SG 11155	123-151	104-132	104-132	104-132
SG 11156	172-201	154-182	154-182	154-182

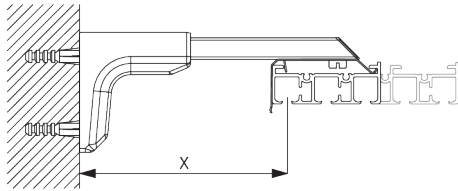

Universal Smart Fix SG 11154 - SG 11156:

Bracket SG 10136 for 2 channel profile.

Bracket SG 10137 for more than 2 channel profiles.

Screw SG 10492 (M4x8) needed.

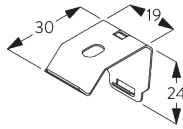

SG 10136

Bracket

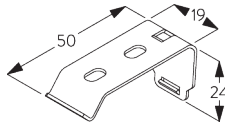

SG 10137

Bracket



SG 10395

Pan head screw M4x6



SG 10492

Pan head screw M4x8

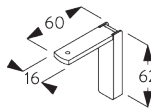

SG 11200

Smart Fix 60 mm

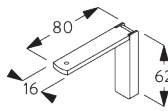

SG 11201

Smart Fix 80 mm

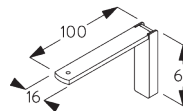

SG 11202

Smart Fix 100 mm

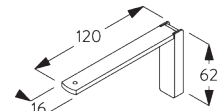

SG 11203

Smart Fix 120 mm

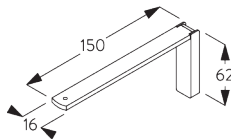

SG 11204

Smart Fix 150 mm

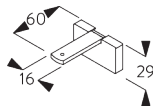

SG 11210

Square Smart Fix 60 mm

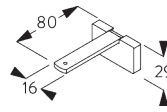

SG 11211

Square Smart Fix 80 mm

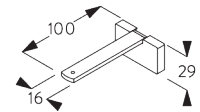

SG 11212

Square Smart Fix 100 mm

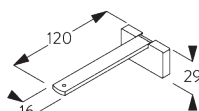

SG 11213

Square Smart Fix 120 mm

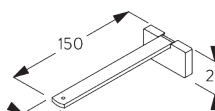

SG 11214

Square Smart Fix 150 mm

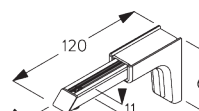

SG 11154

Universal Smart Fix 120 mm

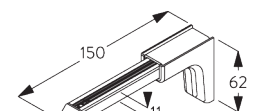

SG 11155

Universal Smart Fix 150 mm

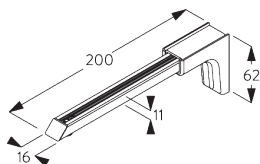

SG 11156

Universal Smart Fix 200 mm

D. RECESS FITTING

Recess profiles
SG 10172 - SG 10175

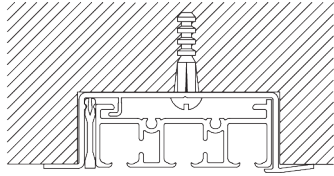

One wedge SG 10157 per fixing point.
For detailed recess fitting, visit the Silent Gliss website.

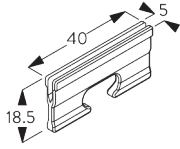

SG 10157
Wedge

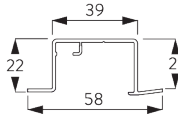

SG 10172
Recess profile 2-channel

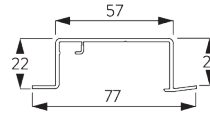

SG 10173
Recess profile 3-channel

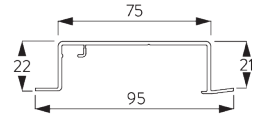

SG 10174
Recess profile 4-channel

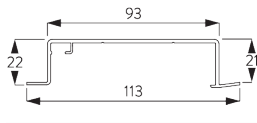

SG 10175
Recess profile 5-channel

SYSTEM OPTIONS

A. OPERATION

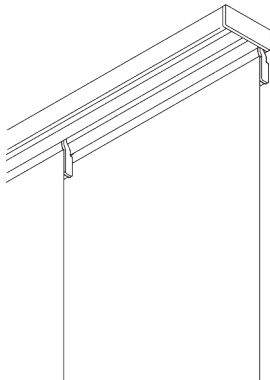

Free floating (unconnected panels)

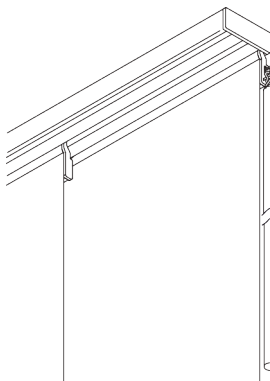

Connected panels (draw rod optional)

B. PANEL STACKING
(CONNECTED)



Single stack
Note: dot = fixed panel









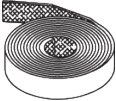

Pair stack
Note: dot = fixed panel



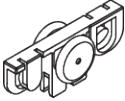







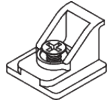

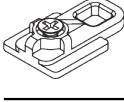

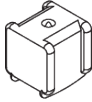
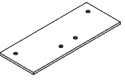
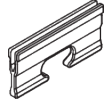
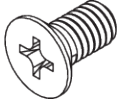
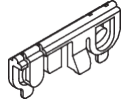

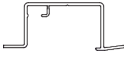
Other variations are possible.

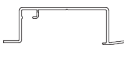
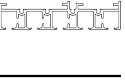
PARTS

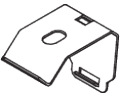
A. STANDARD PARTS

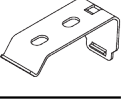
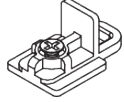
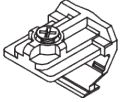
	SG 2004 Bottom bar 20x7 mm
	SG 2539 Tape
	SG 3003 Clamp
	SG 10123 Profile 3-channel
	SG 10143 Cover
	SG 10159 Countersunk head screw 3.5x13
	SG 10200 2C roller
	SG 10230 Carrier alu
	SG 10252 End cover left
	SG 10253 End cover right

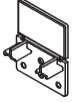
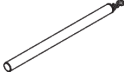
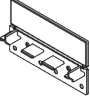
B. OPTIONAL PARTS

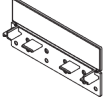
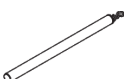
	SG 2005 Bottom bar 40x5 mm		SG 10146 Angle
	SG 3004 Clamp		SG 10148 Eyelet for draw rod
	SG 3008 Connection bridge		SG 10156 End stop
	SG 6024 Connection bridge		SG 10157 Wedge
	SG 10074 Countersunk head screw M4x8		SG 10158 Click glider
	SG 10122 Profile 2-channel		SG 10172 Recess profile 2-channel
	SG 10124 Profile 4-channel		SG 10173 Recess profile 3-channel
	SG 10125 Profile 5-channel		SG 10174 Recess profile 4-channel
	SG 10136 Bracket		SG 10175 Recess profile 5-channel
	SG 10137 Bracket		SG 10340 Eyelet for draw rod
	SG 10140 Angle		SG 10395 Pan head screw M4x6
	SG 10142 End cover		SG 10430 Draw rod 50 cm
	SG 10144 End cover		SG 10431 Draw rod 75 cm
	SG 10145 End cover		SG 10432 Draw rod 100 cm

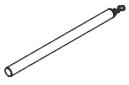

SG 10433

Draw rod 125 cm

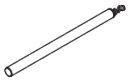

SG 10434

Draw rod 150 cm

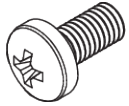

SG 10492

Pan head screw M4x8

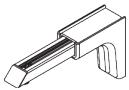

SG 11154

Universal Smart Fix 120 mm

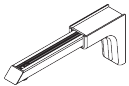

SG 11155

Universal Smart Fix 150 mm

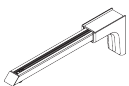

SG 11156

Universal Smart Fix 200 mm

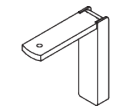

SG 11200

Smart Fix 60 mm

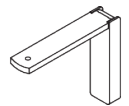

SG 11201

Smart Fix 80 mm

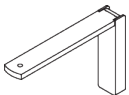

SG 11202

Smart Fix 100 mm

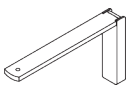

SG 11203

Smart Fix 120 mm



SG 11204

Smart Fix 150 mm

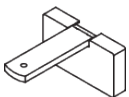

SG 11210

Square Smart Fix 60 mm

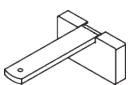

SG 11211

Square Smart Fix 80 mm

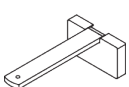

SG 11212

Square Smart Fix 100 mm

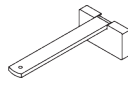

SG 11213

Square Smart Fix 120 mm

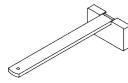

SG 11214

Square Smart Fix 150 mm

