

MOTORS AND CONTROLS

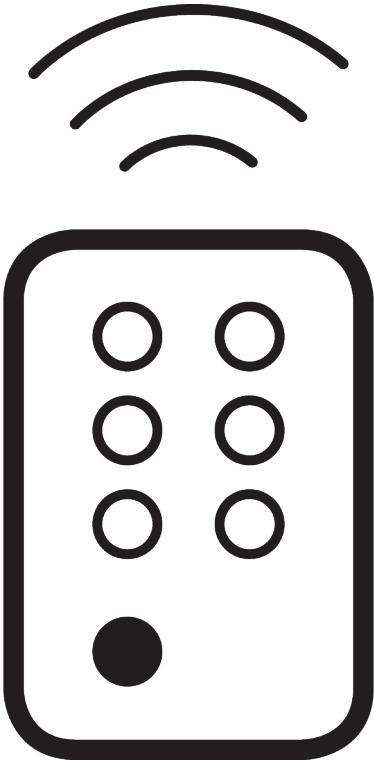

GENERAL NOTES

- *Installation by qualified fitter only.*
- *All radio installations must be installed according to local regulations.*
- *Electrical installations must be carried out according to Silent Gliss wiring diagrams.*
- *Check space for cables and plugs!*

APPLICATION CHART

<u>PAGE</u>	<u>SYSTEM</u>
5	SG Control A
11	SG Control L

SG Control A

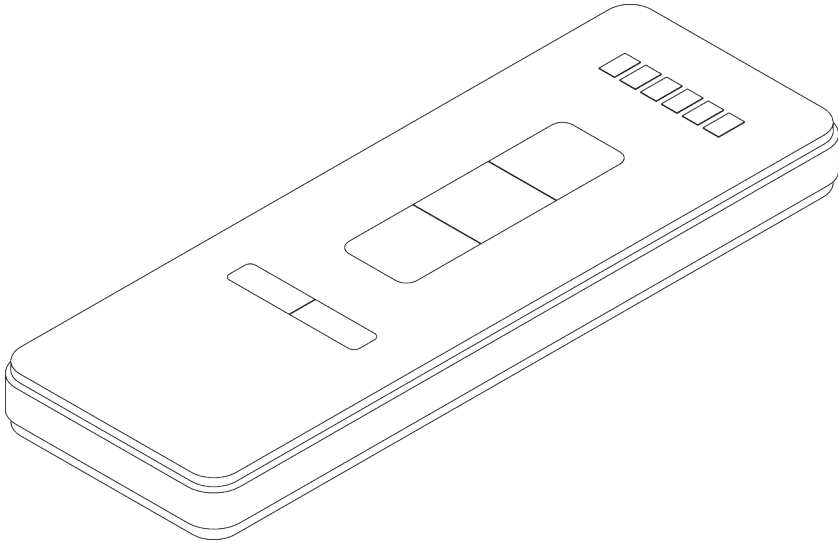

PRODUCT INFORMATION

- *Radio controlled*
- *1-channel, 2-channel, 5-channel or 6-channel radio controls*
- *Radio hand held and wall controls*
- *Single and multi channel timer units*

APPLICATION

A. SYSTEMS

- Electric curtain track system SG 5100
- Panel Glide System SG 2750
- Roller blind system SG 4955
- Roman blind system SG 2345

OVERVIEW COMPONENTS

A. RADIO CONTROLS

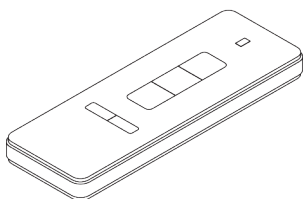

SG 10946

- **Channel:** 1 channel
- **Frequency:** 433.92 MHz
- **Colours:** white

Features:

- Operates single system or operates one group of systems

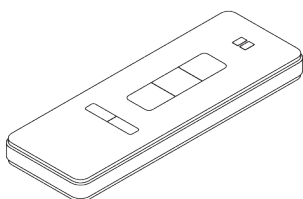

SG 10947

- **Channel:** 2+1 channel
- **Frequency:** 433.92 MHz
- **Colours:** white

Features:

- 2 channel: operates up to two single systems individually
- 2 channel: operates up to two groups of systems individually
- 1 channel: operates all systems together

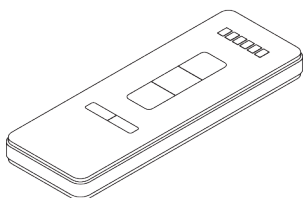

SG 10948

- **Channel:** 6+1 channel
- **Frequency:** 433.92 MHz
- **Colours:** white

Features:

- 6 channel: operates up to 6 single systems individually
- 6 channel: operates up to 6 groups of systems individually
- 1 channel: operates all systems together

B. RADIO WALL CONTROLS

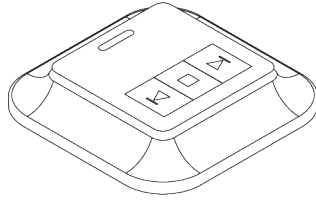

SG 10949

- **Channel:** 1 channel
- **Frequency:** 433.92 MHz
- **Colours:** white

Features:

- Operates single system or operates one group of systems

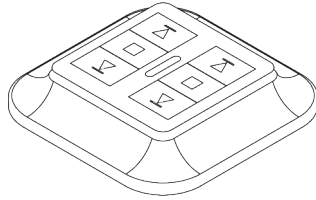

SG 10950

- **Channel:** 2 channel
- **Frequency:** 433.92 MHz
- **Colours:** white

Features:

- 2 channel: operates up to two single systems individually
- 2 channel: operates up to two groups of systems individually

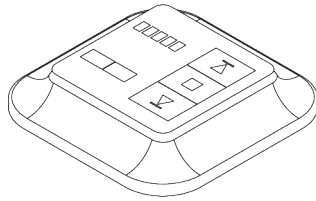

SG 10951

- **Channel:** 5+1 channel
- **Frequency:** 433.92 MHz
- **Colours:** white

Features:

- 5 channel: operates up to 5 single systems individually
- 5 channel: operates up to 5 groups of systems individually
- 1 channel: operates all systems together

C. MANUALS

Refer to Silent Gliss website.

COMBINATION CONTROLS AND SYSTEMS

A. EXAMPLE

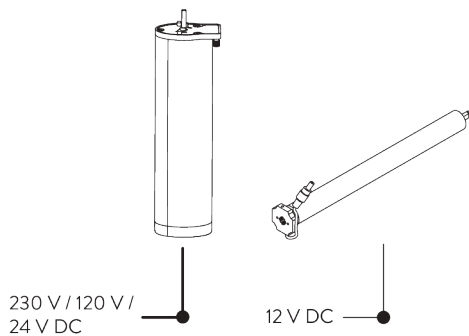

Applicable with following systems:

- Electric curtain track system SG 5100
- Roller blind system SG 4955
- Roman blind system SG 2345

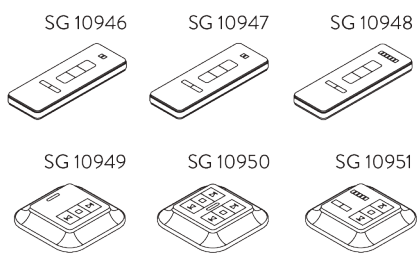

B. WIRING DIAGRAMS



Refer to Silent Gliss website.

PARTS

A. CONTROLS



SG 10946

Radio hand held 1 channel



SG 10947

Radio hand held 2+1 channel



SG 10948

Radio hand held 6+1 channel



SG 10949

Radio wall transmitter 1 channel



SG 10950

Radio wall transmitter 2 channel



SG 10951

Radio wall transmitter 5+1 channel

SG Control L

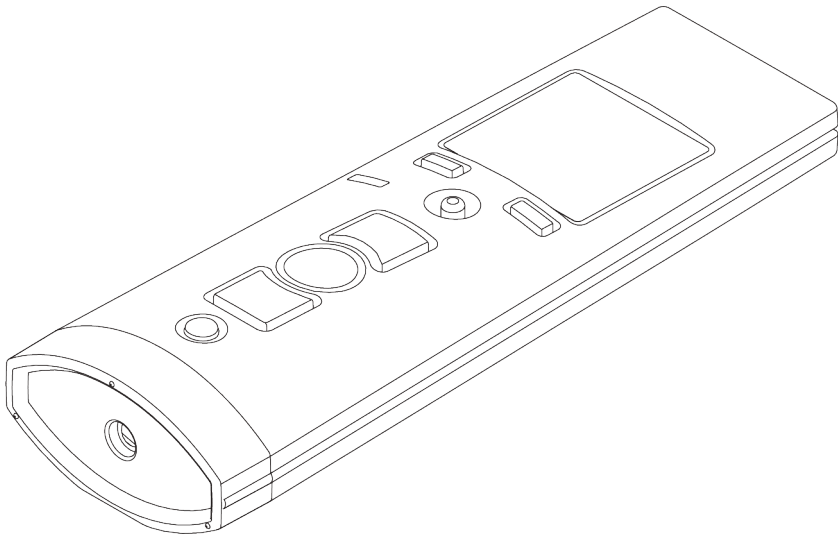

PRODUCT INFORMATION

- *Radio controlled*
- *Bi directional*
- *1-channel, 5-channel, 10-channel or 15-channel radio controls*
- *Radio hand held and wall controls*
- *Radio receivers for motors without integrated receiver*
- *Silent Gliss Move App*

APPLICATION

A. SYSTEMS

- Dim-out blind system SG 4760
- Dim-out blind system SG 4770
- Dim-out blind system SG 4780
- Electric curtain track system SG 5600
- Electric curtain track system SG 5800
- Panel Glide System SG 2750
- Pleated blind system SG 8500
- Roller blind system SG 4960
- Roller blind system SG 4970
- Roller blind system SG 4880
- Roman blind system SG 2350
- Skylight shading system SG 2195
- Skylight shading system SG 8600
- Skylight shading system SG 8640
- Venetian blind system SG 8250
- Venetian blind system SG 8960
- Vertical blind system SG 2950

OVERVIEW COMPONENTS

A. RADIO CONTROLS

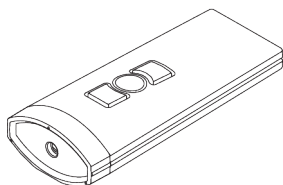

SG 10300

- **Channel:** 1 channel
- **Frequency:** 868 or 915 MHz
- **Colours:** white, silver and anthracite

Features:

- Operates single system or operates one group of systems
- Wall holder in corresponding colour

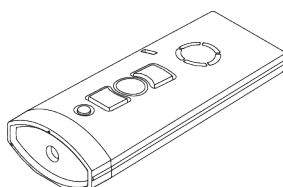

SG 10302

- **Channel:** 5+1 channel
- **Frequency:** 868 or 915 MHz
- **Colours:** white, silver and anthracite

Features:

- 5 channel: operates up to 5 single systems individually
- 5 channel: operates up to 5 groups of systems individually
- 1 channel: operates all systems together
- Wall holder in corresponding colour

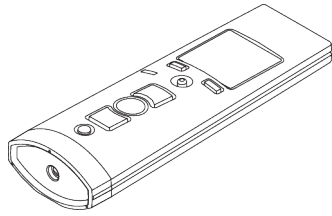

SG 10303

- **Channel:** 10+2+1 channel
- **Frequency:** 868 or 915 MHz
- **Colours:** white, silver and anthracite

Features:

- 10 channel: operates up to 10 single systems individually
- 10 channel: operates up to 10 groups of systems individually
- 2 channel: combines the 10 groups into 2 groups and operates them individually
- 1 channel: operates all systems together
- Various languages
- Programmable day and week, sunrise and sunset time
- Holiday mode
- Illuminated display
- Astro times
- Wall holder in corresponding colour

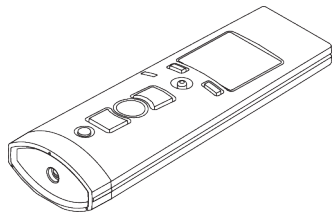

SG 10804

- Channel: 15+5+1 channel
- Frequency: 868 or 915 Mhz
- Colours: white, silver and anthracite

Features:

- 15 channel: operates up to 15 single systems individually
- 15 channel: operates up to 15 groups of systems individually
- 5 channel: combines the 15 groups into 5 groups and operates them individually
- 1 channel: operates all systems together
- Various languages
- Intelligent display management
- Wall holder in corresponding colour

B. RADIO WALL CONTROLS

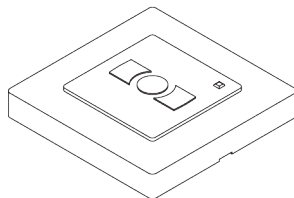

SG 11480

- **Channel:** 1 channel
- **Frequency:** 868 or 915 MHz
- **Colours:** white

Features:

- Operates single system or operates one group of systems

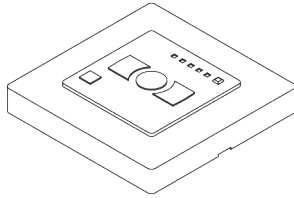

SG 11490

- **Channel:** 5+1 channel
- **Frequency:** 868 or 915 MHz
- **Colours:** white

Features:

- 5 channel: operates up to 5 single systems individually
- 5 channel: operates up to 5 groups of systems individually
- 1 channel: operates all systems together

C. MOVE BY SILENT GLISS

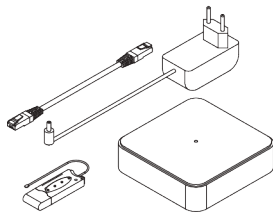

SG 9960

- **Channel:** 15 channel
- **Frequency:** 868 or 915 MHz
- **Colours:** black
- **Move server set:** consists of server and transmitter stick SG 9961

Features:

- Operates up to 15 single systems individually (per stick)
- Operates up to 15 groups of systems individually (per stick)
- Slot for two transmitter sticks SG 9961
- App available for Android and IOS
- Various languages
- "Scenes" programmable
- Programmable day and week, sunrise and sunset time
- Holiday mode
- Astro times

D. RADIO RECEIVERS

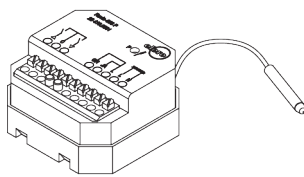

SG 9068

- **Channel:** 1 channel
- **Frequency:** 868 or 915 MHz
- **Voltage:** 230 or 120 V

Features:

- Operates single system
- Flush mounting

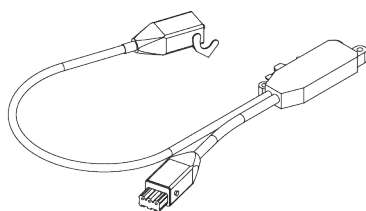

SG 9944

- **Channel:** 1 channel
- **Frequency:** 868 or 915 MHz
- **Voltage:** 230 or 120 V

Features:

- Operates single system
- Non latching mode

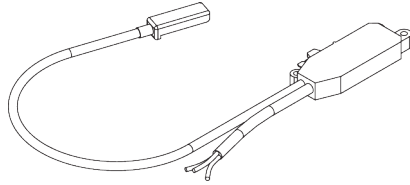

SG 9945

- **Channel:** 1 channel
- **Frequency:** 868 or 915 MHz
- **Voltage:** 230 or 120 V

Features:

- Operates single system
- Latching mode

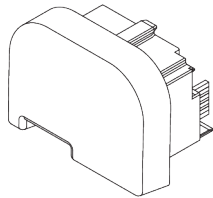

SG 9063

- **Channel:** 1 channel
- **Frequency:** 868 or 915 MHz

Features:

- Only applicable with motor SG 9060 (electric curtain track system SG 5600)

E. CONTROL UNIT

DC

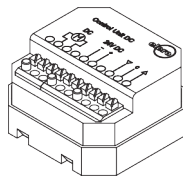

SG 9947

- **Voltage:** 24 V DC

Features:

- Relay
- Flush mounting
- Needed with SG 8250 or SG 8500

F. MANUALS

Refer to Silent Gliss website.

COMBINATION CONTROLS / RECEIVERS AND SYSTEMS

A. EXAMPLES

Motors with integrated receiver

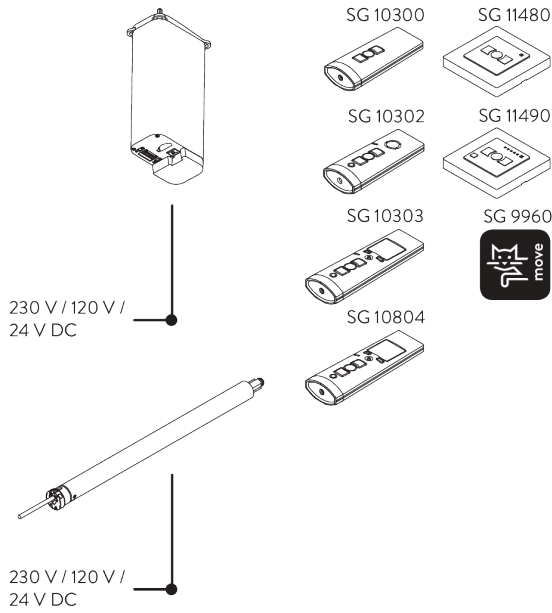

Applicable with following systems:

- Dim-out blind system SG 4760
- Dim-out blind system SG 4770
- Dim-out blind system SG 4780
- Electric curtain track system SG 5600
- Panel glide system SG 2750
- Roller blind system SG 4960
- Roller blind system SG 4970
- Roller blind system SG 4880
- Roman blind system SG 2350
- Vertical blind system SG 2950
- Venetian blind system SG 8960 (230 V)

Motors without integrated receiver

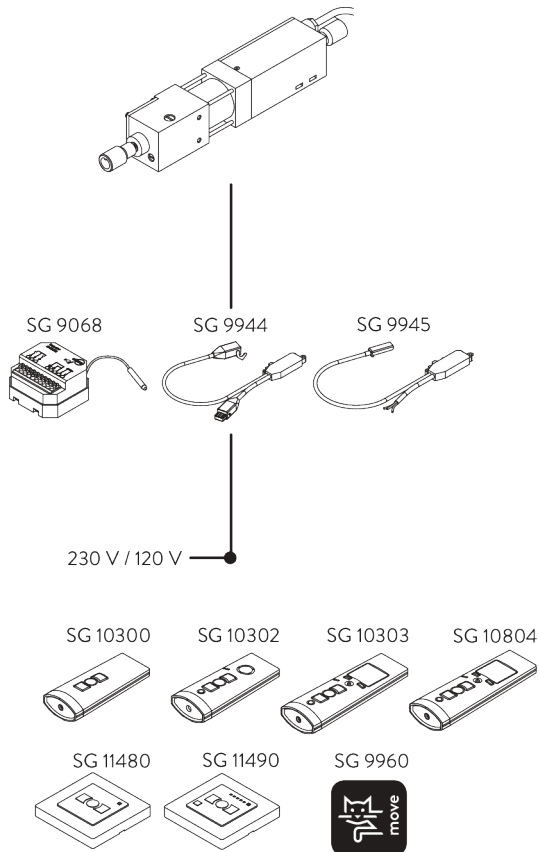

Applicable with following systems:

- Electric curtain track system SG 5800
- Skylight shading system SG 2195
- Skylight shading system SG 8600
- Skylight shading system SG 8640

**24 V DC motors
without integrated
receiver**

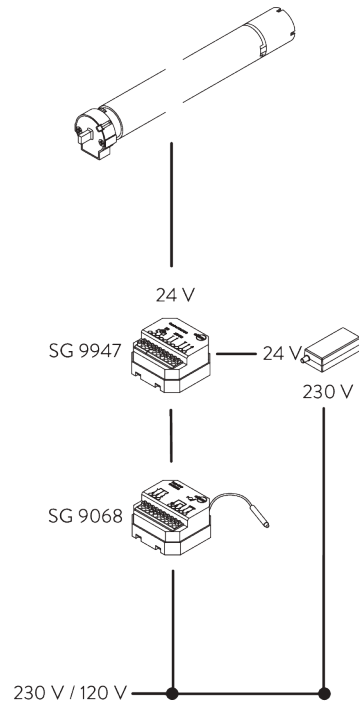

Applicable with following systems:

- Roller blind system SG 4960
- Pleated blind system SG 8500
- Venetian blind system SG 8250

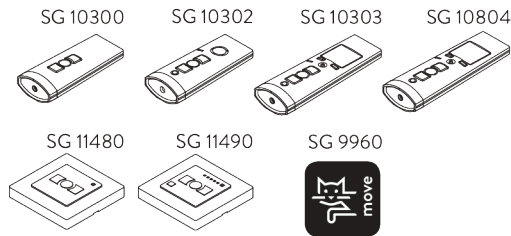

**B. WIRING
DIAGRAMS**



Refer to Silent Gliss website.

PARTS

A. CONTROLS / RECEIVERS

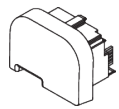

SG 9063

Radio module type L

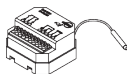

SG 9068

Radio receiver Revio

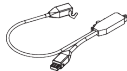

SG 9944

Radio receiver 1 channel



SG 9945

Radio receiver 1 channel

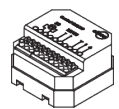

SG 9947

Control unit DC 24V

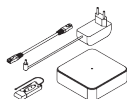

SG 9960

Move server set

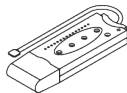

SG 9961

Move transmitter



SG 10300

Radio hand held 1 channel



SG 10302

Radio hand held 5+1 channel



SG 10303

Radio hand held 10+2+1 channel



SG 10804

Radio hand held 15+5+1 channel



SG 11480

Radio wall transmitter 1 channel



SG 11490

Radio wall transmitter 5+1 channel

The Architects of Silence

Silent Gliss is the leading global supplier of premium interior window treatments. Since 1952 we have been tirelessly committed to the development of the worlds` smoothest, quietest systems using state of the art technology.

Driven by customer needs, Silent Gliss offers functional and durable products. Expert technical advice coupled with installation and support services complete the offer. Silent Gliss stands for innovative, sustainable, tailor made solutions, exceptional design and first-class quality.

Oy Vallila Contract Ab

Nilsjankatu 15

FI-00510 Helsinki

T +358 (0)20 776 7700

F +358 (0)20 776 7701

silentgliss@vallilainterior.fi

silentgliss.fi