

# SG 6035

---

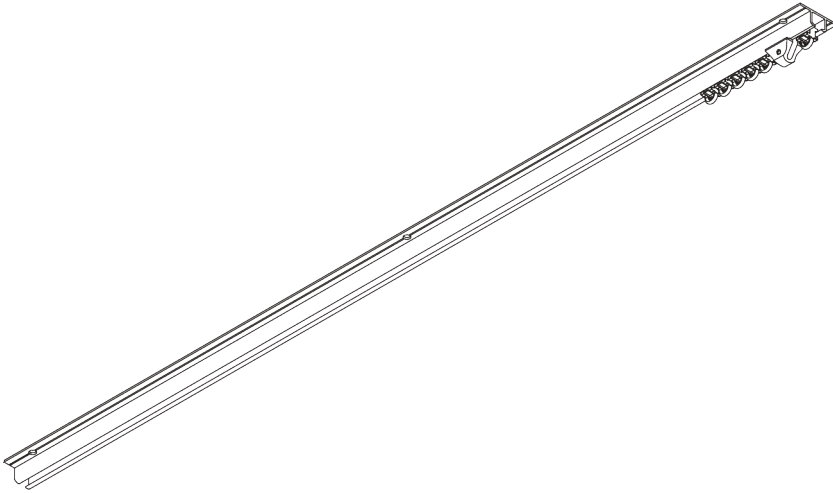

## PRODUCT INFORMATION

- **Operation:** hand
- **Range:** M - L
- **Fitting:** ceiling
- **Colours:** white RAL 9016 or anodised aluminum, special colours possible
- **Fabrics:** refer to Silent Gliss fabric collection

### **Features:**

- 2-component (2C) glider technology
- Wave (2C)
- Bendable
- Pre-drilled profile

# SYSTEM SPECIFICATIONS

## A. PROFILE

Profile and bending information

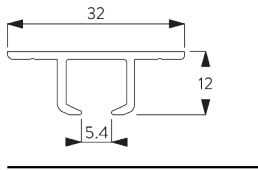

SG 6035p

Profile

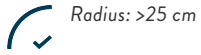

Radius: >25 cm

## B. HOW TO MEASURE

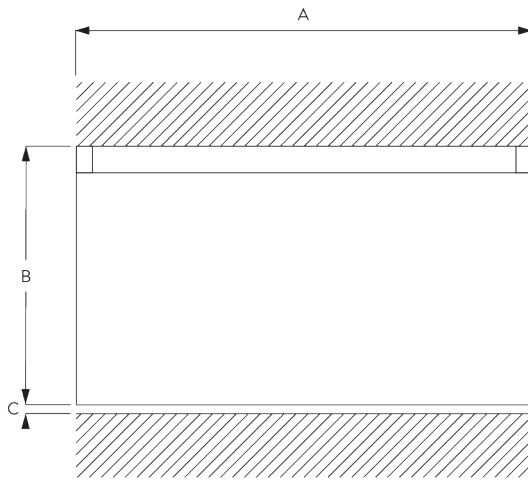

A: System width

B: System height

C: Distance between floor and fabric

# FITTING

## A. FITTING INFORMATION

Fixing points

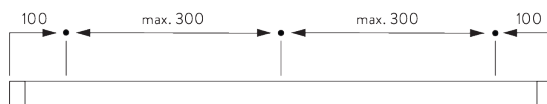

For detailed fitting information, visit the [Silent Gliss website](#).

## B. CEILING FITTING

Direct fitting

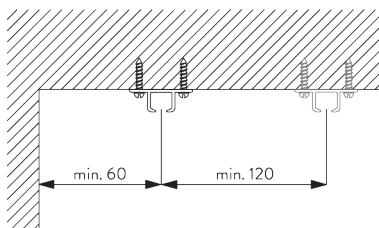

# SYSTEM OPTIONS

## A. WAVE

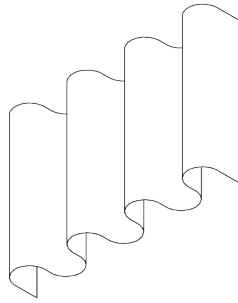

SG 11295

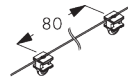

SG 11302



SG 2255



SG 2256

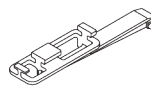

SG 6364



SG 6365

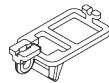

SG 6366

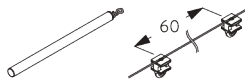

SG 10430-34

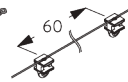

SG 11303

### Standard components:

- SG 11295 End stop
- SG 11302 Wave 2C glider cord 80 mm

### Optional components:

- SG 2255 Brake
- SG 2256 Brake
- SG 6364 Wave extension
- SG 6365 Wave hanger
- SG 6366 Wave carrier for draw rod
- SG 10430-34 Draw rod
- SG 11303 Wave 2C glider cord 60 mm



SG 3582

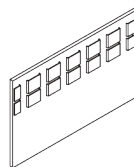

SG 6349

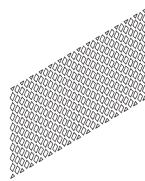

SG 6363

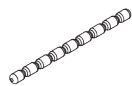

SG 10075



SG 10076

### Curtain components:

- SG 3582 Hook
- SG 6349 Wave curtain tape
- SG 6363 Wave top hemming tape
- SG 10075 Lead weight 50 gr/m
- SG 10076 Fabric weight

Wave stack depth - 2C glider cord (standard components)

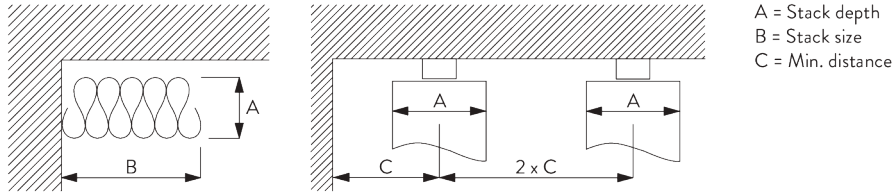





2C Glider cord SG 11302	Pockets between hooks	Approx. curtain fullness	Stack depth A	Stack size B*	Min distance C
80	6	~2.1	140	180 per metre of track	90
80	7	~2.3	160	180 per metre of track	100

2C Glider cord SG 11303	Pockets between hooks	Approx. curtain fullness	Stack depth A	Stack size B*	Min distance C
60	4	~2.1	100	230 per metre of track	70
60	5	~2.3	120	230 per metre of track	80











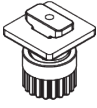

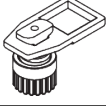



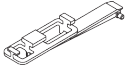

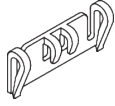

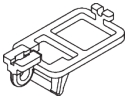

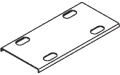
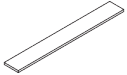
\*Stack size B when using optional extension arm SG 6364 increases by 150 mm per curtain stack!

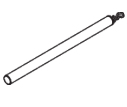
# PARTS

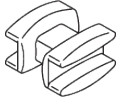
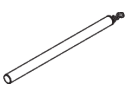
## A. STANDARD PARTS

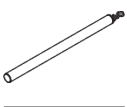
	<b>SG 3599</b> Hook
	<b>SG 6035p</b> Profile
	<b>SG 6065</b> End stop
	<b>SG 6086</b> Spring stop
	<b>SG 11300</b> 2C glider

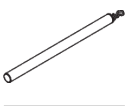
## B. OPTIONAL PARTS

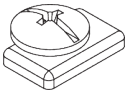
	<b>SG 2255</b> Brake		<b>SG 6283</b> Roller
	<b>SG 2256</b> Brake		<b>SG 6349</b> Wave curtain tape
	<b>SG 3012</b> Hook		<b>SG 6363</b> Wave top hemming tape
	<b>SG 3571</b> Hook		<b>SG 6364</b> Wave extension
	<b>SG 3582</b> Hook		<b>SG 6365</b> Wave hanger
	<b>SG 6004</b> Eyelet		<b>SG 6366</b> Wave carrier for draw rod
	<b>SG 6005</b> Hook		<b>SG 10075</b> Lead weight 50 g/m
	<b>SG 6043</b> Connection bridge		<b>SG 10076</b> Fabric weight
	<b>SG 6053</b> Spring stop		<b>SG 10430</b> Draw rod 50 cm
	<b>SG 6057</b> Glider		<b>SG 10431</b> Draw rod 75 cm
	<b>SG 6082</b> Glider		<b>SG 10432</b> Draw rod 100 cm
	<b>SG 6094</b> Roller		<b>SG 10433</b> Draw rod 125 cm
	<b>SG 6098</b> Roller		<b>SG 10434</b> Draw rod 150 cm
	<b>SG 6240</b> Roller		<b>SG 11295</b> End stop



---

**SG 11301**

*2C glider on strip*

---

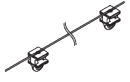

---

**SG 11302**

*Wave 2C glider cord 80 mm*

---

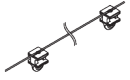

---

**SG 11303**

*Wave 2C glider cord 60 mm*

---

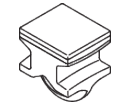

---

**SG 11305**

*2C glider for direct sewing*

---



