

# SG 5100

---

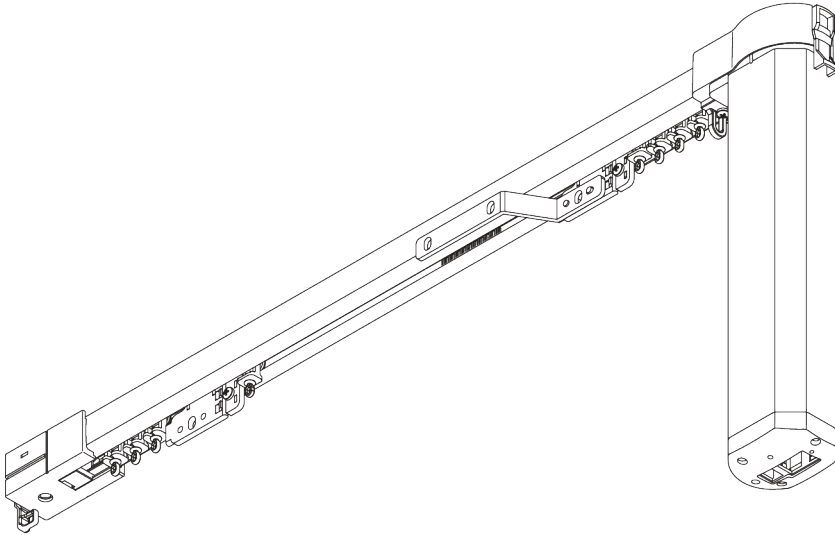
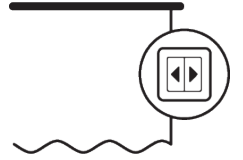

## PRODUCT INFORMATION

- **Operation:** motorised
- **Range:** S - M
- **Fitting:** ceiling, wall
- **Colours:** white RAL 9016
- **Fabrics:** refer to Silent Gliss fabric collection

### **Features:**

- Wave
- Various control options
- Touch & Go
- Manual override
- Different motor versions
- Bendable

# SYSTEM SPECIFICATIONS

## A. SYSTEM DIMENSIONS

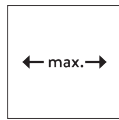

6 m



25 kg

### Max. curtain weights with rollers

	3 m	6 m
	20	25
	20	25
	20	17
	20	17
	15	13
	15	13
	12	10
	12	10
(kg max.)		

### Max. curtain weights with Wave gliders

	3 m	6 m
	20	20
	20	20
	18	14
	18	14
	12	10
	12	10
	10	9
	10	9
(kg max.)		

## B. PROFILE

### Profile and bending information

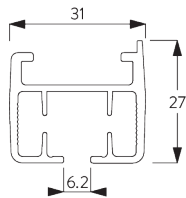

**SG 10925**

Profile



## C. HOW TO MEASURE

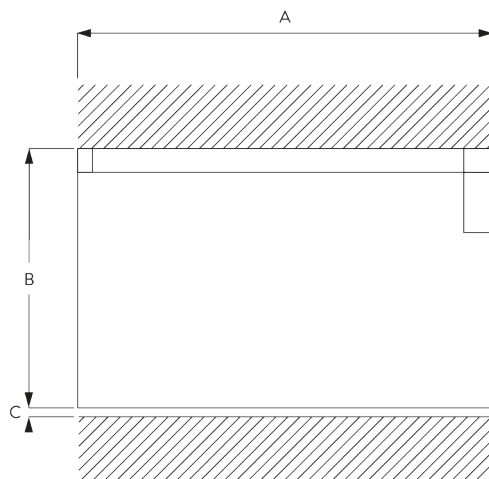

A: System width  
B: System height  
C: Distance between floor and fabric

## D. SPECIFICATION TEXT

### EN

Silent Gliss SG 5100 Electrically Operated Curtain Track. Comprises aluminium profile SG 10925 in white complete and assembled with motor SG 5190, internal drive belt SG 10825, gliders SG 10931 at 10/m. Ceiling fix with SG 10926 clamps/ face fix with Smart Fix at maximum 500 mm centres. Operation via wireless wall switch SG 10946-49 or via low voltage contacts. Silent Gliss Wave option is available.

### SV

Silent Gliss SG 5100 eldragssystem. Består av aluminiumprofil SG 10925 i specificerad längd i vitlack eller angiven RAL färg med motor SG 5190 monterad. 10 st SG 10931 glid per meter. Takmonteras med fäste SG 10926 c/c 500 mm. Vägghontering med SG Smart Fix c/c 500 mm. Styrning med trådlös väggsändare SG 10946-49 eller med lågvoltkontakt. Kan användas med system Wave.

### NO

Silent Gliss SG 5100 Elektrisk gardinskinne. Består av aluminiumprofil SG 10925 i spesifisert lengde, standard i hvitlakkert eller spesifisert RAL farge. Motor SG 5190. 10 stk SG 10931 glide per meter. Takmonteres med feste SG 10926 c/c 500 mm. Veggmontering med SG Smart Fix c/c 500 mm. Styring med trådløs veggsender SG 10946-49 eller med lavvolt kontakt. Kan kombineres med Wave system.

### DA

Silent Gliss SG 5100 elektrisk gardinskinnesystem. Består af aluminiumprofil SG 10925 i hvidt, fuldstændig samlet med motor SG 5190, drivrem SG 10825, 10 stk. glide SG 10931 pr. m. Loftmonteres med klemmer SG 10926 clamps/ væghonteres med Smart Fix med en afstand på højst 500 mm. Styres med en trådløs vægkontakt SG 10946-49 eller lavspændingskontakter. Kan bruges med Silent Gliss Wave.

# FITTING

## A. FITTING INFORMATION

For detailed fitting information, visit the Silent Gliss website.

### Fixing points

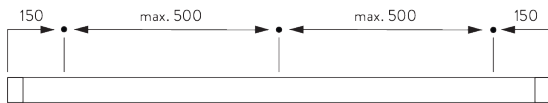

## B. CEILING FITTING

### Clamp SG 10926

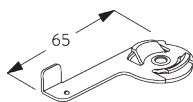
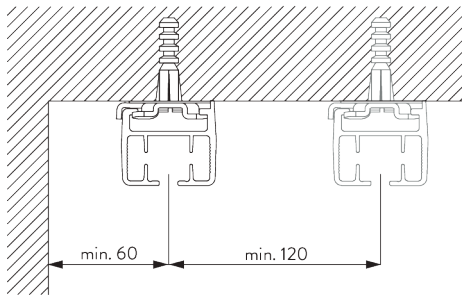

**SG 10926**

Clamp

## C. WALL FITTING

### Smart Fix

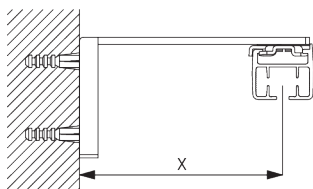

**Smart Fix SG 11201 - SG 11205 and clamp SG 10926:**  
Screw SG 11127 (M4x10) needed.

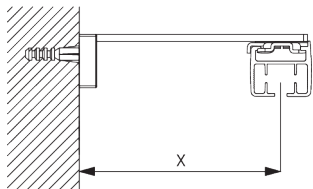

**Square Smart Fix SG 11211 - SG 11215 and clamp SG 10926:**  
Screw SG 11127 (M4x10) needed.

Smart Fix	X mm
SG 11201 / SG 11211	72
SG 11202 / SG 11212	92
SG 11203 / SG 11213	112
SG 11204 / SG 11214	142
SG 11205 / SG 11215	192
SG 11154	102-130
SG 11155	132-160
SG 11156	182-210

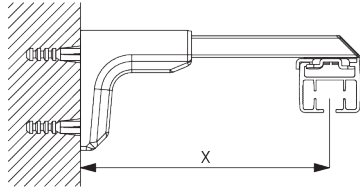

**Universal Smart Fix SG 11154 - SG 11156 and clamp  
SG 10926:**

Screw SG 11158 (M4x12) needed.

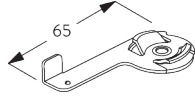

**SG 10926**  
Clamp



**SG 11127**  
Countersunk head screw  
M4x10



**SG 11158**  
Countersunk head screw  
M4x12

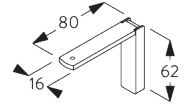

**SG 11201**  
Smart Fix 80 mm

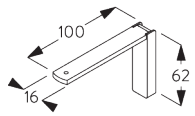

**SG 11202**  
Smart Fix 100 mm

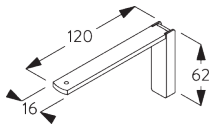

**SG 11203**  
Smart Fix 120 mm

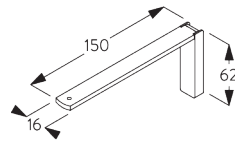

**SG 11204**  
Smart Fix 150 mm

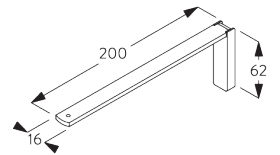

**SG 11205**  
Smart Fix 200 mm

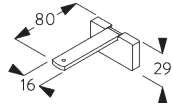

**SG 11211**  
Square Smart Fix 80 mm

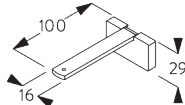

**SG 11212**  
Square Smart Fix 100 mm

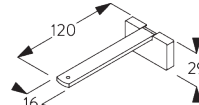

**SG 11213**  
Square Smart Fix 120 mm

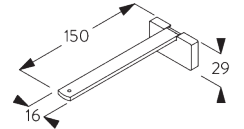

**SG 11214**  
Square Smart Fix 150 mm

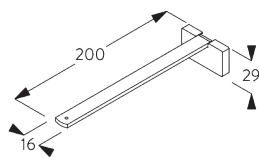

**SG 11215**  
Square Smart Fix 200 mm

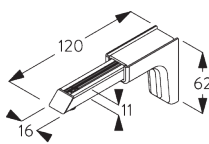

**SG 11154**  
Universal Smart Fix 120 mm

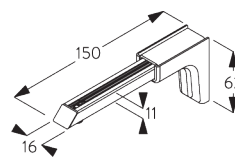

**SG 11155**  
Universal Smart Fix 150 mm

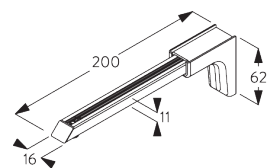

**SG 11156**  
Universal Smart Fix 200 mm

# SYSTEM OPTIONS

## A. WAVE

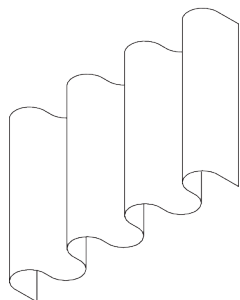

SG 6365



SG 10854



SG 10856



SG 10867



SG 10887

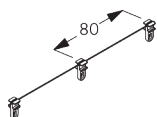

SG 10905

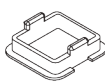

SG 10924

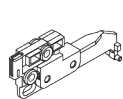

SG 10845

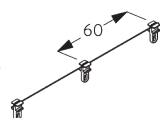

SG 10906



SG 3582

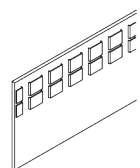

SG 6349

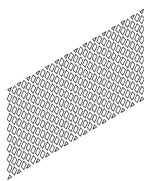

SG 6363

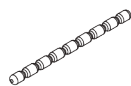

SG 10075



SG 10076

### Standard components:

- SG 6365 Wave hanger
- SG 10854 Wave overlap arm support
- SG 10856 Wave end stop, belt return
- SG 10867 Panhead screw
- SG 10887 Wave overlap arm set
- SG 10905 Wave glider cord 80 mm
- SG 10924 Wave glider support

### Optional components:

- SG 10845 Wave master carrier single stack 80 mm
- SG 10906 Wave glider cord 60 mm (no single stack)

### Curtain components:

- SG 3582 Hook
- SG 6349 Wave curtain tape
- SG 6363 Wave top hemming tape
- SG 10075 Lead weight 50 gr/m
- SG 10076 Fabric weight

Wave stack depth - glider cord (standard components)

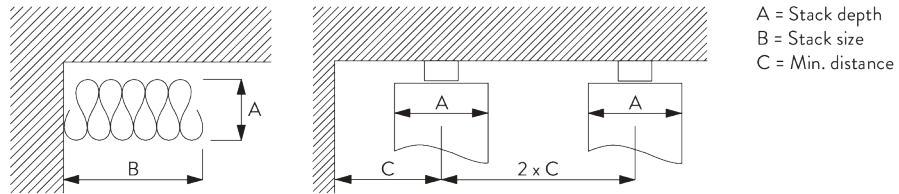

Glider cord SG 10905	Pockets between hooks	Approx. curtain fullness	Stack depth A	Stack size B*	Min distance C
80	6	~2.1	140	180 per metre of track	90
80	7	~2.3	160	180 per metre of track	100

Glider cord SG 10906	Pockets between hooks	Approx. curtain fullness	Stack depth A	Stack size B*	Min distance C
60	4	~2.1	100	230 per metre of track	70
60	5	~2.3	120	230 per metre of track	80

\*Stack size B plus 180 mm for each curtain stack!

# MOTORS & CONTROLS

## A. MOTOR FEATURES

Motors	SG 5190	SG 5192	SG 5193
<b>Motor Features</b>			
Soft start / stop	●	●	●
Touch & Go	●	●	
Manual Override	●	●	●
Built-in receiver	●	●	
Electronic end-stop	●	●	●
Electronic revolution counter (unlimited revolution)	●	●	●
Parallel wiring possible without additional relays	●	●	●
Cable connectable with plug into motor		●	
IP class	IP 20	IP 20	IP 20
<b>Control Features</b>			
Mains power control			●
Dry contact control	●	●	
Dry contact and / or SG Control A	●	●	
SG Control A	●	●	
Suitable for all common home automation systems (with suitable interface)	●	●	●

**B. MOTOR  
SPECIFICATIONS**

Motors	Motor dimensions	Voltage	Current	Frequency	System speed / sec	Frequency receiver
SG 5190	L 293 x W 53 x D 68	100 - 240 V AC	0.8 - 0.4 A	50 / 60 Hz	15 cm / sec	433 MHz
SG 5192	L 293 x W 53 x D 68	24 V DC	3.5 A	n/a	15 cm / sec	433 MHz
SG 5193	L 293 x W 53 x D 68	100 - 240 V AC	0.8 - 0.4 A	50 / 60 Hz	15 cm / sec	n/a

**C. MOTOR  
DIMENSIONS**

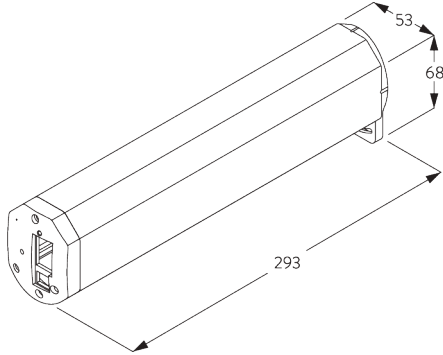

**D. OPERATING  
METHODS**

See catalogue "controls" for details.

Wall switch



System can be operated by fixed wall switch.

Silent Gliss Control A



Various radio hand-held and wall transmitters available.

**E. WIRING  
DIAGRAMS**





Refer to Silent Gliss website.





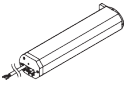
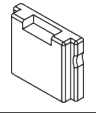
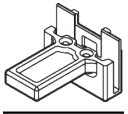
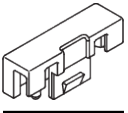
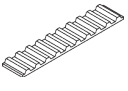
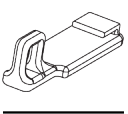
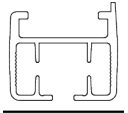

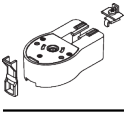
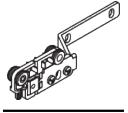
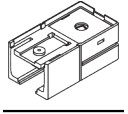
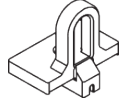

# PARTS

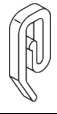
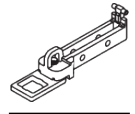
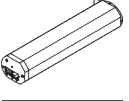
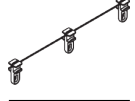
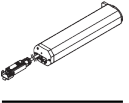
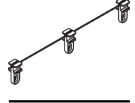
## A. STANDARD PARTS

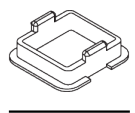
	<b>SG 5190</b> Motor 100-240V AC, 1/130, radio receiver
	<b>SG 10815</b> Cover
	<b>SG 10823</b> Belt connector arm
	<b>SG 10824</b> Belt connector pin
	<b>SG 10825</b> Belt
	<b>SG 10836</b> Mask pair stack
	<b>SG 10925</b> Profile
	<b>SG 10926</b> Clamp
	<b>SG 10931</b> Roller
	<b>SG 10933</b> Gear drive set
	<b>SG 10936</b> Overlap arm
	<b>SG 10940</b> Guide return
	<b>SG 10945</b> End stop

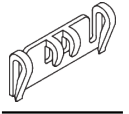
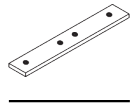
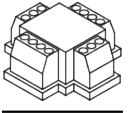
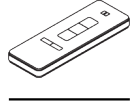
## B. OPTIONAL PARTS

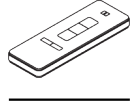
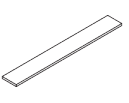
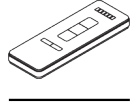
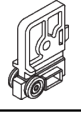
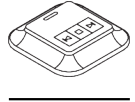
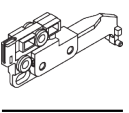
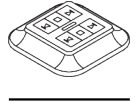
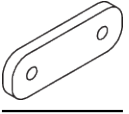
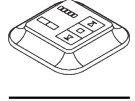
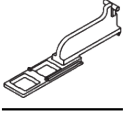
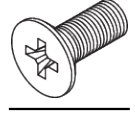
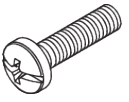
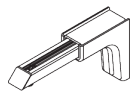
	<b>SG 3582</b> Hook		<b>SG 10887</b> Wave extension
	<b>SG 5192</b> Motor 24V DC, 1/130, radio receiver		<b>SG 10905</b> Wave glider cord 80 mm
	<b>SG 5193</b> Motor 100-240V AC, 1/130, mains controlled		<b>SG 10906</b> Wave glider cord 60 mm
	<b>SG 6349</b> Wave curtain tape		<b>SG 10924</b> Wave glider support
	<b>SG 6363</b> Wave top hemming tape		<b>SG 10927</b> Hook
	<b>SG 6365</b> Wave hanger		<b>SG 10943</b> Connection bridge
	<b>SG 9959</b> Central control unit relay		<b>SG 10946</b> Radio hand held 1 channel
	<b>SG 10075</b> Lead weight 50 g/m		<b>SG 10947</b> Radio hand held 2+1 channel
	<b>SG 10076</b> Fabric weight		<b>SG 10948</b> Radio hand held 6+1 channel
	<b>SG 10822</b> Master carrier		<b>SG 10949</b> Radio wall transmitter 1 channel
	<b>SG 10845</b> Wave master carrier 80 mm		<b>SG 10950</b> Radio wall transmitter 2 channel
	<b>SG 10854</b> Wave overlap plate		<b>SG 10951</b> Radio wall transmitter 5+1 channel
	<b>SG 10856</b> Wave extension		<b>SG 11127</b> Countersunk head screw M4x10
	<b>SG 10867</b> Pan head screw Freedriv M4x16		<b>SG 11154</b> Universal Smart Fix 120 mm

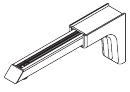
**SG 11155**

Universal Smart Fix 150 mm

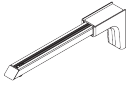
**SG 11156**

Universal Smart Fix 200 mm

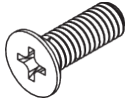
**SG 11158**

Countersunk head screw M4x12

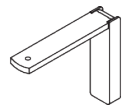
**SG 11201**

Smart Fix 80 mm

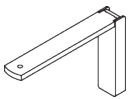
**SG 11202**

Smart Fix 100 mm

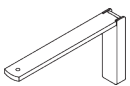
**SG 11203**

Smart Fix 120 mm

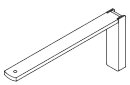
**SG 11204**

Smart Fix 150 mm

**SG 11205**

Smart Fix 200 mm

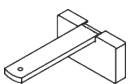
**SG 11211**

Square Smart Fix 80 mm

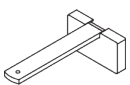
**SG 11212**

Square Smart Fix 100 mm

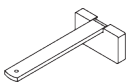
**SG 11213**

Square Smart Fix 120 mm

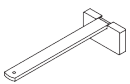
**SG 11214**

Square Smart Fix 150 mm

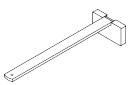
**SG 11215**

Square Smart Fix 200 mm

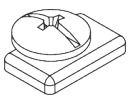
**SG 11295**

End stop

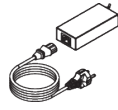
**SG 11414**

Power supply 24V / 4A including  
cable EU plug



